

Serial Wiring with Input/Output Unit 5 Port Solenoid Valve for EX250 Series SV/VQC

Series	Applicable protocol	Applicable manifold
Serial wiring with input/output unit EX250	DeviceNet™	SV1000 2000 3000
	PROFIBUS-DP	
	CC-Link	
	AS-i	VQC1000 2000 4000
	CANopen	
	ControlNet™	
	EtherNet/IP™	

EtherNet/IP™ compatible products are now available.

- Compatible with DHCP
- Communication speed: 10 M/100 Mbps
- Able to HOLD/CLEAR the output in case of an error occurrence.

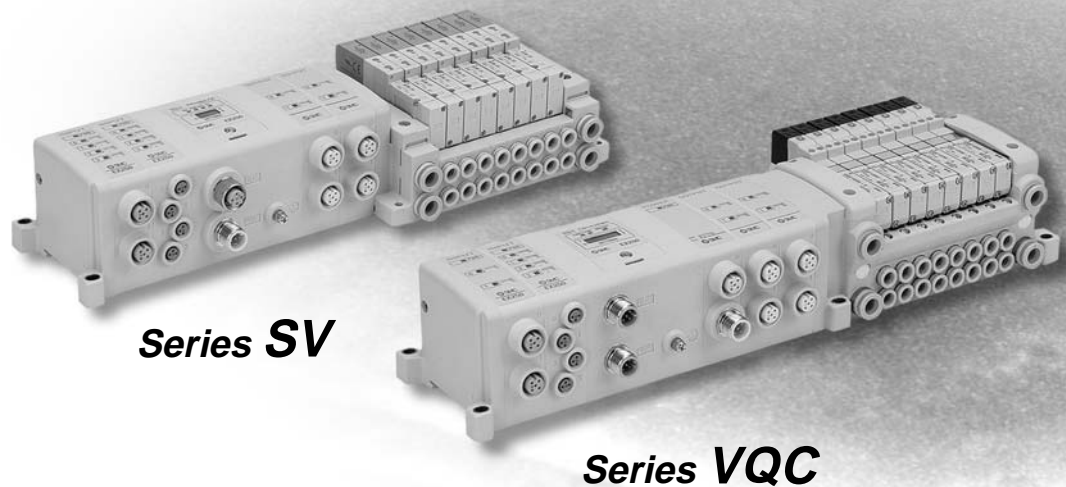

Series SV

Series VQC

DeviceNet™ is a trademark of ODVA.
 ControlNet™ is a trademark of ControlNet International.
 EtherNet/IP™ is a trademark used under license by ODVA.

EX250 Serial Wiring With Input/Output Unit Series SV



For details about certified products conforming to international standards, visit us at www.smcworld.com.

How to Order

Tie-rod Base

SS5V 1 - W 10S1 QW [] [] [] D - 05 U [] [] []

Series	
1	SV1000
2	SV2000
3	SV3000

Enclosure
IP67 specification

Input block stations

-	None
1	1 station
⋮	⋮
8	8 stations

Note) Without SI unit, the symbol is "-".
When an AS-i compatible SI unit is used, there is a limit to the maximum number of stations. For details, please refer to page 13.

SI unit	
QW	DeviceNet
NW	PROFIBUS-DP
VW	CC-Link
TAW	AS-i 8in/8out 31Slave Mode, 2 power supply system
TBW	AS-i 4in/4out 31Slave Mode, 2 power supply system
TCW	AS-i 8in/8out 31Slave Mode, 1 power supply system
TDW	AS-i 4in/4out 31Slave Mode, 1 power supply system
YW	CANopen
ZCN	ControlNet (IP40)
ZEN	EtherNet/IP
0	Without SI unit, Without end plate

Mounting

-	Direct mounting	
D	DIN rail mounting (with DIN rail)	
D0 ^{Note)}	DIN rail mounting (without DIN rail)	
D3	3 stations	When a longer DIN rail is desired than the specified stations. (Specify a longer rail than the standard length.)
⋮	⋮	
D20	20 stations	

Note) In the case of D0, only DIN rail brackets are attached.

- Input blocks cannot be mounted without an SI unit.
- When the DIN rail is included without an SI unit, the DIN rail length will accommodate an SI unit and one input block.

Note 1) There is a limit to the current supplied from an AS-i compatible SI unit, 1 power supply system specification to an input block or valve. For details, refer to page 13.

Note 2) IP40 for the ControlNet compatible SI unit. (Manifold model no. is "SS5V□-10S1ZCN□□□□D".)

Note 3) For SI unit part no., refer to page 3.

Input block type

-	Without input block
1	M12 2 inputs
2	M12 4 inputs
3	M8 4 inputs

Note) Without SI unit, the symbol is "-".

Input block common specification

-	+COM. or without input block
N	-COM.

Stations

Symbol	No. of stations	Note
02	2 stations	Double wiring specification ^{Note 1)}
⋮	⋮	
16	16 stations	Specified layout ^{Note 2)} (Up to 32 solenoids possible.)
02	2 stations	
⋮	⋮	
20	20 stations	

Note) When an AS-i compatible SI unit is used, the maximum numbers of solenoids are as follows:
8in/8out specification: Maximum 8 solenoids
4in/4out specification: Maximum 4 solenoids

Note 1) Double wiring specification: Single, double, 3 position and 4 position solenoid valves can be used on all manifold stations. Use of a single solenoid will result in an unused control signal. If this is not desired, order with a specified layout.

Note 2) Specified layout: Indicate the wiring specification on a manifold specification sheet. (Note that double, 3 position and 4 position valves cannot be used where single solenoid wiring has been specified.)

P, E port position

U	U side (2 to 10 stations)
D	D side (2 to 10 stations)
B	Both sides (2 to 20 stations)

SUP/EXH block assembly specification

-	Internal pilot
S ^{Note)}	Internal pilot, Built-in silencer
R	External pilot
RS ^{Note)}	External pilot, Built-in silencer

Note) When the built-in silencer type is used, keep the exhaust port away from direct contact with water or other liquids.

A, B port size (Metric)

Symbol	A, B port	P, E port	Applicable series
C3	With one-touch fitting for ø3.2	With one-touch fitting for ø8	SV1000
C4	With one-touch fitting for ø4		
C6	With one-touch fitting for ø6		
C4	With one-touch fitting for ø4	With one-touch fitting for ø10	SV2000
C6	With one-touch fitting for ø6		
C8	With one-touch fitting for ø8		
C6	With one-touch fitting for ø6	With one-touch fitting for ø12	SV3000
C8	With one-touch fitting for ø8		
C10	With one-touch fitting for ø10		
M	A, B ports mixed		

A, B port size (Inch)

Symbol	A, B port	P, E port	Applicable series
N1	With one-touch fitting for ø1/8"	With one-touch fitting for ø5/16"	SV1000
N3	With one-touch fitting for ø5/32"		
N7	With one-touch fitting for ø1/4"		
N3	With one-touch fitting for ø5/32"	With one-touch fitting for ø3/8"	SV2000
N7	With one-touch fitting for ø1/4"		
N9	With one-touch fitting for ø5/16"		
N7	With one-touch fitting for ø1/4"	With one-touch fitting for ø3/8"	SV3000
N9	With one-touch fitting for ø5/16"		
N11	With one-touch fitting for ø3/8"		
M	A, B ports mixed		

* In the case of a mixed specification (M), indicate separately on a manifold specification sheet.

* The port sizes for the X, PE ports of the external pilot specification (R, RS) are ø4 (metric), ø5/32" (inch) for the SV1000/2000 series and ø6 (metric) and ø1/4" (inch) for the SV3000 series.

How to Order Valve Manifold Assembly (Example)

Example (SV1000)

Manifold
SS5V1-W10S1QW11ND-05B-C6 (1 set)

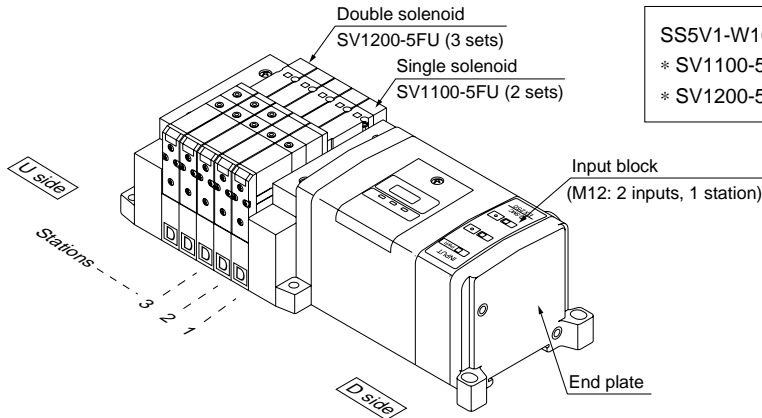

SS5V1-W10S1QW11ND-05B-C6 1 set (Manifold base part no.)
 * SV1100-5FU 2 sets (Single solenoid part no.)
 * SV1200-5FU 2 sets (Double solenoid part no.)

How to Order Solenoid Valves

SV 1 1 0 0 - 5 F

Series

1	SV1000
2	SV2000
3	SV3000

Type of actuation

1	2 position single solenoid
2	2 position double solenoid
3	3 position closed centre
4	3 position exhaust centre
5	3 position pressure centre
A	4 position dual 3 port valve: N.C./N.C.
B	4 position dual 3 port valve: N.O./N.O.
C	4 position dual 3 port valve: N.C./N.O.

* 4 position dual 3 port valves are applicable to the SV1000 and SV2000 series only.

Pilot

-	Internal pilot
R	External pilot

* External pilot specification is not applicable for 4 position dual 3 port valves.

Back pressure check valve

-K	None
	Built-in

* Built-in back pressure check valve type is applicable to the SV1000 series only.

Note)



Note) Available with manifold block for station additions. Refer to SMC's "Best Pneumatics" catalogue.

Manual override

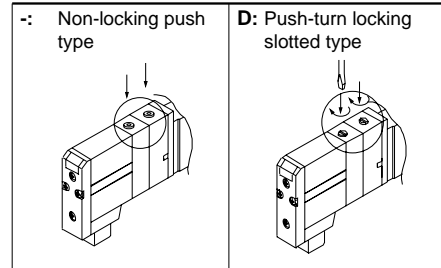

Light/surge voltage suppressor

U	With light/surge voltage suppressor
R	With surge voltage suppressor

Rated voltage

5	24 VDC
---	--------

- For solenoid valve specifications and dimensions, refer to the SV series in the SMC's "Best Pneumatics" catalogue.
- For SI unit dimensions, refer to page 12.
- For details on the SI unit, refer to the separate technical instruction manual.

SI Unit Part No.

SI Unit Part No.

Symbol	Protocol type	SI unit part no.
QW	DeviceNet	EX250-SDN1
NW	PROFIBUS-DP	EX250-SPR1
VW	CC-Link	EX250-SMJ2
YW	CANopen	EX250-SCA1A
ZCN	ControlNet	EX250-SCN1

Symbol	Protocol type	SI unit part no.
TAW	AS-i 8in/8out 31Slave Mode, 2 power supply system	EX250-SAS3
TBW	AS-i 4in/4out 31Slave Mode, 2 power supply system	EX250-SAS5
TCW	AS-i 8in/8out 31Slave Mode, 1 power supply system	EX250-SAS7
TDW	AS-i 4in/4out 31Slave Mode, 1 power supply system	EX250-SAS9
ZEN	EtherNet/IP	EX250-SEN1

Series VQC1000

Base Mounted

Plug-in Manifold CE



For details about certified products conforming to international standards, visit us at www.smcworld.com.

How to Order Manifold

VV5QC 1 1 — 08 C6 SDQ [] [] [] [] — B S Kit

Series

1	VQC1000
---	---------

Manifold

1	Plug-in manifold
---	------------------

Stations

01	1 station
⋮	⋮

The maximum number of stations differs depending on the kits.

Cylinder port size

C3	With one-touch fitting for ø3.2
C4	With one-touch fitting for ø4
C6	With one-touch fitting for ø6
M5	M5 thread
CM	Mixed size/with port plug
L3	Elbow top ported with one-touch fitting for ø3.2
L4	Elbow top ported with one-touch fitting for ø4
L6	Elbow top ported with one-touch fitting for ø6
L5	M5 thread
B3	Elbow bottom ported with one-touch fitting for ø3.2
B4	Elbow bottom ported with one-touch fitting for ø4
B6	Elbow bottom ported with one-touch fitting for ø6
B5	M5 thread
LM	Mixed size for elbow piping



Note 1) Indicate the size on a manifold specification sheet in the case of "CM" and "LM".

Note 2) Symbols for inch sizes are as follows:

- N1: ø1/8"
- N3: ø5/32"
- N7: ø1/4"
- NM: Mixed

The top ported elbow is LN□ and the bottom ported elbow is BN□.

Kit name

(For details on kits, refer to the next page.)

Option

-	None
B	With back pressure check valve (all stations) <small>Note 2)</small>
D	With DIN rail (Rail length: Standard)
D□	With DIN rail (Rail length: Special) <small>Note 3)</small>
K	Special wiring specification (Except double wiring) <small>Note 4)</small>
N	With name plate
R	External pilot <small>Note 5)</small>
S	Built-in silencer, Direct exhaust <small>Note 6)</small>



Note 1) When two or more options are specified, indicate them alphabetically.
Example) -BRS

Note 2) When installing a back pressure check valve on the required station, enter the part number and specify the station position on a manifold specification sheet.

Note 3) For special DIN rail length, indicate "D□". (Enter the number of stations inside □.)
Example: -D08

In this case, stations will be mounted on a DIN rail for 8 stations regardless of the actual number of manifold stations.

The specified number of stations must be larger than the number of stations on the manifold. Indicate "D0" for the option without DIN rail.

Note 4) Be sure to indicate the wiring specification on a manifold specification sheet.

Note 5) For external pilot option, "-R", indicate the external pilot specification "R" for the applicable valves as well.

Note 6) The built-in silencer type does not satisfy the IP67 standard.

Input block COM.

-	PNP or without input block
N	NPN

Input block type

-	Without input block
1	M12 2 inputs
2	M12 4 inputs
3	M8 4 inputs

Number of input blocks

-	Without SI unit
0	Without input block
1	With 1-input block
⋮	⋮
8	With 8-input block

Note) When an AS-i compatible SI unit is used, there is a limit to the maximum number of stations. For details, please refer to page 13.

SI unit COM.

SI unit COM.		EX250						
		DeviceNet	PROFIBUS-DP	CC-Link	AS-i	CANopen	ControlNet	EtherNet/IP
-	+COM.	—	—	○	—	—	—	—
N	-COM.	○	○	—	○	○	○	○



Note) Without SI unit, the symbol is "-".

How to Order Valves

VQC 1 1 0 0 **5**

Series
1 VQC1000

Type of actuation

1	2 position single 	A (Note)	4 position dual 3 port valve (A)
	2 position double (Metal) 		B (Note)
2	2 position double (Rubber) 	C (Note)	4 position dual 3 port valve (B)
	4 position dual 3 port valve (C) 		
3	3 position closed centre 	Note) Rubber seal type only.	
4	3 position exhaust centre 		
5	3 position pressure centre 		

With/Without light/surge voltage suppressor

- Yes

Rated voltage

5 24 VDC

Function

-	Standard (1 W)
K (Note 2)	High-pressure type (1.0 MPa)
N	Negative COM.
R (Note 3)	External pilot
Y (Note 4)	Low-wattage type (0.5 W)

- Note 1) When two or more symbols are specified, indicate them alphabetically.
- Note 2) Metal seal type only.
- Note 3) Not applicable to 4 position dual 3 port valves.
- Note 4) Use a low wattage type for continuous energisation (when the total energised time per day is longer than the non-energised time.)

Seal

0	Metal seal
1	Rubber seal

Manual override

- : Non-locking push type (Tool required)
- B: Locking type (Tool required)
- C: Locking type (Manual)
- D: Slide locking type (Manual)

Kit name

S Kit (Serial transmission kit for I/O)

SI unit: **EX250**

IP40 **IP67**

Symbol	Protocol type	No. of stations	SI unit part no.
SD0	Without SI unit, Without end plate		—
SDQ	DeviceNet	1 to 12 stations (24 stations)	EX250-SDN1
SDN	PROFIBUS-DP		EX250-SPR1
SDV	CC-Link		EX250-SMJ2
SDTA	AS-i 8in/8out 31Slave Mode, 2 power supply system	1 to 4 stations (8 stations)	EX250-SAS3
SDTB	AS-i 4in/4out 31Slave Mode, 2 power supply system	1 to 2 stations (4 stations)	EX250-SAS5
SDTC (Note)	AS-i 8in/8out 31Slave Mode, 1 power supply system	1 to 4 stations (8 stations)	EX250-SAS7
SDTD (Note)	AS-i 4in/4out 31Slave Mode, 1 power supply system	1 to 2 stations (4 stations)	EX250-SAS9
SDY	CANopen		EX250-SCA1A
SDZCN	ControlNet (IP40)	1 to 12 stations (24 stations)	EX250-SCN1
SDZEN	EtherNet/IP		EX250-SEN1

Note) There is a limit to the current supplied from an SI unit of the SDTC or SDTD specification to an input block or valve. For details, refer to page 13.
 • IP40 for the ControlNet compatible SI unit. (The other SI units are compatible with IP67 ratings.)

- For solenoid valve specifications and dimensions, refer to the VQC series in SMC's "Best Pneumatics" catalogue.
- For SI unit dimensions, refer to page 12.
- For details on the SI unit, refer to the separate technical instruction manual.

Series VQC2000

Base Mounted

Plug-in Manifold



For details about certified products conforming to international standards, visit us at www.smcworld.com.

How to Order Manifold

VV5QC 21 — 08 C6 SDQ [] [] [] [] — B S Kit

Series
2 VQC2000

Manifold
1 Plug-in manifold

Stations
01 1 station
: :
: :

The maximum number of stations differs depending on the kits.

Cylinder port size

C4	With one-touch fitting for ø4
C6	With one-touch fitting for ø6
C8	With one-touch fitting for ø8
CM	Mixed size/with port plug
L4	Elbow top ported with one-touch fitting for ø4
L6	Elbow top ported with one-touch fitting for ø6
L8	Elbow top ported with one-touch fitting for ø8
B4	Elbow bottom ported with one-touch fitting for ø4
B6	Elbow bottom ported with one-touch fitting for ø6
B8	Elbow bottom ported with one-touch fitting for ø8
LM	Mixed size for elbow piping



Note 1) Indicate the size on a manifold specification sheet in the case of "CM" and "LM".

Note 2) Symbols for inch sizes are as follows:

• N3: ø5/32"

• N7: ø1/4"

• N9: ø5/16"

• NM: Mixed

The top ported elbow is LN□ and the bottom ported elbow is BN□.

Kit name

(For details on kits, refer to the next page.)

Option

-	None
B	With back pressure check valve (all stations) <small>Note 2)</small>
D	With DIN rail (Rail length: Standard)
D□	With DIN rail (Rail length: Special) <small>Note 3)</small>
K	Special wiring specification (Except double wiring) <small>Note 4)</small>
N	With name plate
R	External pilot <small>Note 5)</small>
S	Built-in silencer, Direct exhaust <small>Note 6)</small>
T	P, R port on U side, branched type <small>Note 7)</small>



Note 1) When two or more options are specified, indicate them alphabetically.
Example) -BRS

Note 2) When installing a back pressure check valve on the required station, enter the part number and specify the station position on a manifold specification sheet.

Note 3) For special DIN rail length, indicate "D□". (Enter the number of stations inside □.)
Example: -D08

In this case, stations will be mounted on a DIN rail for 8 stations regardless of the actual number of manifold stations.

The specified number of stations must be larger than the number of stations on the manifold.

Indicate "D0" for the option without DIN rail.

Note 4) Be sure to indicate the wiring specification on a manifold specification sheet.

Note 5) For external pilot option, "-R", indicate the external pilot specification "R" for the applicable valves as well.

Note 6) The built-in silencer type does not satisfy the IP67 standard.

Note 7) The SUP and EXH ports on U side are branched (toward the cylinder port and coil) with ø12 one-touch fittings for connection.

Input block COM.

-	PNP or without input block
N	NPN

Input block type

-	Without input block
1	M12 2 inputs
2	M12 4 inputs
3	M8 4 inputs

Number of input blocks

-	Without SI unit
0	Without input block
1	With 1-input block
:	:
8	With 8-input block

Note) When an AS-i compatible SI unit is used, there is a limit to the maximum number of stations. For details, please refer to page 13.

SI unit COM.

SI unit COM.		EX250						
		DeviceNet	PROFIBUS-DP	CC-Link	AS-i	CANopen	ControlNet	EtherNet/IP
-	+COM.	—	—	○	—	—	—	—
N	-COM.	○	○	—	○	○	○	○



Note) Without SI unit, the symbol is "-".

How to Order Valves

VQC 2 1 0 0 **5**

Series
2 VQC2000

Type of actuation

1	2 position single 	A (Note) 4 position dual 3 port valve (A)
	2 position double (Metal) 	
2	2 position double (Rubber) 	B (Note) 4 position dual 3 port valve (B)
	3 position closed centre 	
3	3 position exhaust centre 	C (Note) 4 position dual 3 port valve (C)
	3 position pressure centre 	
4	3 position exhaust centre 	
5	3 position pressure centre 	

Note) Rubber seal type only.

With/Without light/surge voltage suppressor
- Yes

Rated voltage
5 24 VDC

Function

-	Standard (1 W)
K (Note 2)	High-pressure type (1.0 MPa)
N	Negative COM.
R (Note 3)	External pilot
Y (Note 4)	Low-wattage type (0.5 W)

Note 1) When two or more symbols are specified, indicate them alphabetically.
 Note 2) Metal seal type only.
 Note 3) Not applicable to 4 positions dual 3 port valves.
 Note 4) Use a low wattage type for continuous energisation (when the total energised time per day is longer than the non-energised time.)

Seal

0	Metal seal
1	Rubber seal

Manual override

- : Non-locking push type (Tool required)
- B: Locking type (Tool required)
- C: Locking type (Manual)
- D: Slide locking type (Manual)

Kit name

S Kit (Serial transmission kit for I/O)

SI unit: EX250

IP40
IP67

Symbol	Protocol type	No. of stations	SI unit part no.
SD0	Without SI unit, Without end plate		—
SDQ	DeviceNet	1 to 12 stations (24 stations)	EX250-SDN1
SDN	PROFIBUS-DP		EX250-SPR1
SDV	CC-Link		EX250-SMJ2
SDTA	AS-i 8in/8out 31Slave Mode, 2 power supply system	1 to 4 stations (8 stations)	EX250-SAS3
SDTB	AS-i 4in/4out 31Slave Mode, 2 power supply system	1 to 2 stations (4 stations)	EX250-SAS5
SDTC (Note)	AS-i 8in/8out 31Slave Mode, 1 power supply system	1 to 4 stations (8 stations)	EX250-SAS7
SDTD (Note)	AS-i 4in/4out 31Slave Mode, 1 power supply system	1 to 2 stations (4 stations)	EX250-SAS9
SDY	CANopen	1 to 12 stations (24 stations)	EX250-SCA1A
SDZCN	ControlNet (IP40)		EX250-SCN1
SDZEN	EtherNet/IP		EX250-SEN1

Note) There is a limit to the current supplied from an SI unit of the SDTC or SDTD specification to an input block or valve. For details, refer to page 13.
 • IP40 for the ControlNet compatible SI unit. (The other SI units are compatible with IP67 ratings.)

- For solenoid valve specifications and dimensions, refer to the VQC series in SMC's "Best Pneumatics" catalogue.
- For SI unit dimensions, refer to page 12.
- For details on the SI unit, refer to the separate technical instruction manual.



How to Order Valves

VQC 4 1 0 0 **5**

• **Series**

4	VQC4000
----------	---------

• **Type of actuation**

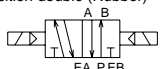
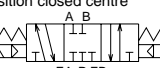
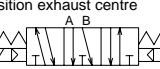
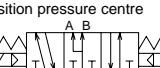
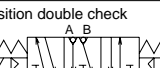
1	2 position single 
2	2 position double (Metal) 
	2 position double (Rubber) 
3	3 position closed centre 
	3 position exhaust centre 
5	3 position pressure centre 
6	3 position double check 

• **With/Without light/surge voltage suppressor**

-	Yes
E	Without light, with surge voltage suppressor

• **Rated voltage**

5	24 VDC
----------	--------

• **Function** Note 1)

-	Standard (1 W)
R	External pilot
Y <small>Note 2)</small>	Low-wattage type (0.5 W)



Note 1) When two or more symbols are specified, indicate them alphabetically.

Note 2) Use a low wattage type for continuous energisation (when the total energised time per day is longer than the non-energised time.)

• **Seal**

0	Metal seal
1	Rubber seal

- For solenoid valve specifications and dimensions, refer to the VQC series in SMC's "Best Pneumatics" catalogue.
- For SI unit dimensions, refer to page 12.
- For details on the SI unit, refer to the separate technical instruction manual.

• **Manual override**

-: Non-locking push type (Tool required)

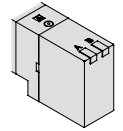

B: Locking type (Tool required)

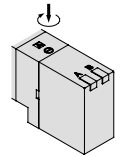

Serial Wiring with Input/Output Unit

Series EX250

Integrated serial wiring

- Ease of mounting, and space-savings are achievable, integrating wiring by connector.

Input/Output number

- Compatible with 32-digital outputs/inputs.

Enclosure

- IP67 compatible (IP40: compliant with ControlNet)

SI Unit

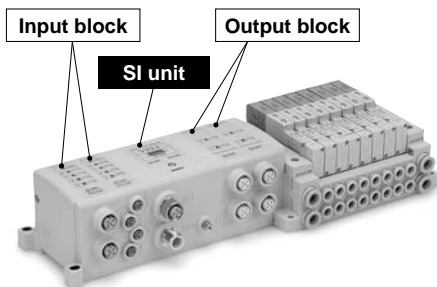
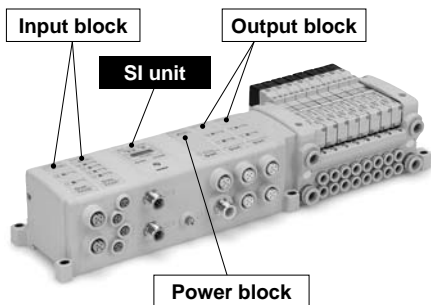

How to Order SI Unit

EX250 – S DN1

Communication protocol

DN1	DeviceNet
PR1	PROFIBUS-DP
MJ2	CC-Link
AS3	AS-i (8in/8out 31Slave Mode, 2 power supply system)
AS5	AS-i (4in/4out 31Slave Mode, 2 power supply system)
AS7	AS-i (8in/8out 31Slave Mode, 1 power supply system)
AS9	AS-i (4in/4out 31Slave Mode, 1 power supply system)
CA1A	CANopen
CN1 <small>Note)</small>	ControlNet
EN1	EtherNet/IP

Note) The enclosure rating is IP40 for the ControlNet compatible SI unit compatible with ControlNet.

For options, refer to page 16.

SI Unit Specifications

Model		EX250-SDN1	EX250-SPR1	EX250-SMJ2	EX250-SCA1A	EX250-SCN1	EX250-SEN1	EX250-SAS3/5	EX250-SAS7/9	
Applicable system	Protocol	DeviceNet	PROFIBUS-DP	CC-Link	CANopen	ControlNet	EtherNet/IP	AS-Interface (AS-i)		
	Version <small>Note 1)</small>	Release 2.0	V0	Ver.1.10	CiA DS-301 V4.02 and CiA DS-401	Version 2.0 Errata 3 adapter class	Release1.0	Version 2.11 Standard Address Mode		
Communication speed		125 k/250 k/500 kbps	9.6 k/19.2 k/45.45 k/93.75 k/187.5 k/500 kbps 1.5 M/3 M/6 M/12 Mbps	156 k/625 kbps 2.5 M/5 M/10 Mbps	10 k/20 k/50 k/125 k/250 k/500 k/800 kbps/1 Mbps	5 Mbps	10 M/100 Mbps	167 kbps		
Power supply for input and internal control	Power supply voltage	21.6 to 26.4 VDC						26.5 to 31.6 VDC <small>Note 2)</small>		
	Internal current consumption	—	100 mA or less						—	
Power supply for output	Power supply voltage	22.8 to 26.4 VDC							<small>Note 2)</small> 26.5 to 31.6 VDC	
Power supply for communication	Power supply voltage	11 to 25 VDC	—				26.5 to 31.6 VDC <small>Note 2)</small>			
	Internal current consumption	100 mA or less	—				SAS3: 100 mA or less SAS5: 65 mA or less	SAS7: 100 mA or less SAS9: 65 mA or less		
Input	Number of inputs	32 points (Based on input block connection) <small>Note 5)</small>						SAS3: 8 points SAS5: 4 points	SAS7: 8 points SAS9: 4 points	
	Supply voltage	24 VDC								
	Supply current	Max. 1.0 A						SAS3: max. 240 mA SAS5: max. 2120 mA	<small>Note 3)</small>	
Output	Output type	PNP output (–COM.)	NPN output (+COM.)	PNP output (–COM.)						
	Number of outputs	32 points						SAS3: 8 points SAS5: 4 points	SAS7: 8 points SAS9: 4 points	
	Connection block	Solenoid valve (single, double), Output block, Power block <small>Note 6)</small>								
	Supply voltage	24 VDC								
	Supply current	Max. 2.0 A						SAS3: max. 500 mA SAS5: max. 250 mA	<small>Note 3)</small>	
Environmental resistance	Enclosure	IP67			IP40		IP67			
	Operating temperature range	Operating: 5 to 45°C Stored: –20 to 60°C (with no freezing and condensation)								
	Operating humidity range	Operating, Stored: 35 to 85%RH (with no condensation)								
	Withstand voltage	500 VAC for 1 min. between whole charging part and case								
	Insulation resistance	10 MΩ or more (500 VDC Mega) between whole charging part and case								
	Vibration resistance	10 to 150 Hz with a 0.7 mm amplitude or 50 m/s ² in each X, Y, Z direction for 2 hrs (De-energised)								
Impact resistance	150 m/s ² in each X, Y, Z direction, 3 times (De-energised)									
Standard		CE marking (CSA)								
Weight		250 g								
Accessory	Tie-rod <small>Note 4)</small>	2 pcs.								

Note 1) Please note that the version is subject to change.

Note 2) The EX250-SAS7/9 is powered by the single system spec., in which the communication power source is separated into input, power supply for internal control, and/or for output.

Note 3) The EX250-SAS7/9 is powered by the single system spec., that is separated for use depending on the aggregated values of input/output supply power as shown below. (For details, refer to page 13.)

EX250-SAS7 ... Max.250 mA, EX250-SAS9 ... Max.120 mA

Note 4) When an SI unit is integrated into a manifold, its tie-rods are also incorporated at the time of shipping.

Note 5) For connected input equipment, refer to page 14.

Note 6) For connected output equipment, refer to page 21.

Maximum Transmission Distance

Model	Maximum transmission distance
EX250-SDN1	500 m (125 kbps), 250 m (250 kbps), 100 m (500 kbps)
EX250-SPR1	23 km (Repeater required)
EX250-SMJ2	1200 m (156 kbps), 900 m (625 kbps), 400 m (2.5 Mbps), 160 m (5 Mbps), 100 m (10 Mbps)
EX250-SCA1A	5000 m (10 kbps), 2000 m (20 kbps), 1000 m (50 kbps), 500 m (125 kbps), 250 m (250 kbps), 100 m (500 kbps), 50 m (800 kbps), 25 m (1 Mbps)
EX250-SCN1	1000 m (Tap number: 2)
EX250-SEN1	100 m (10/100 Mbps)
EX250-SAS3/5	300 m (when using a repeater)
EX250-SAS7/9	

Series EX250

SI Unit Dimensions / Parts Description

EX250-SDN1 (DeviceNet)

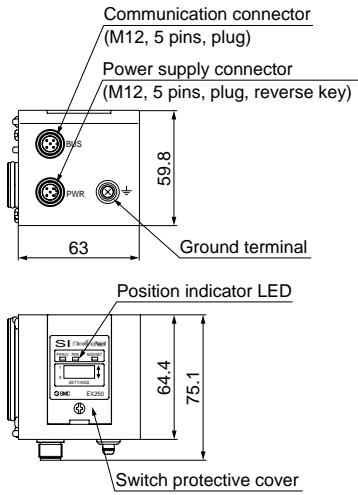

EX250-SPR1 (PROFIBUS-DP)

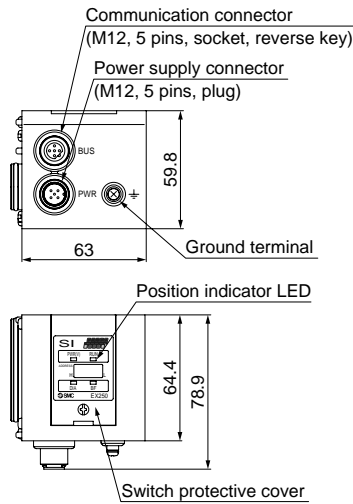

EX250-SMJ2 (CC-Link)

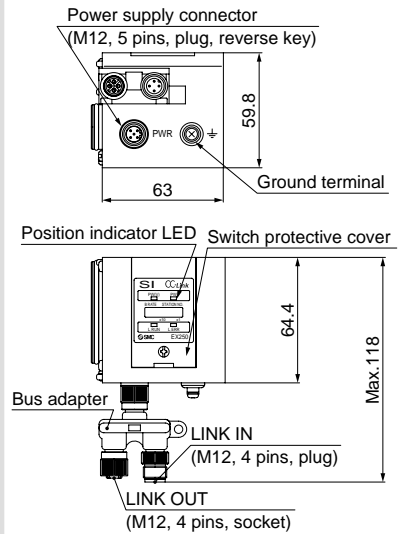

EX250-SCA1A (CANopen)

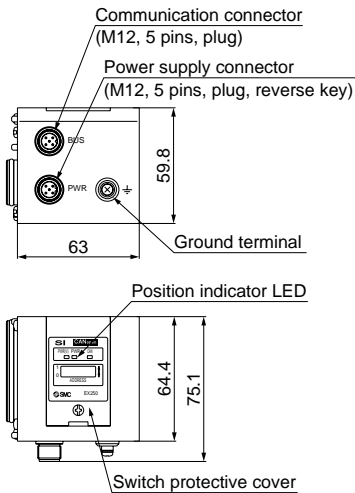

EX250-SCN1 (ControlNet)

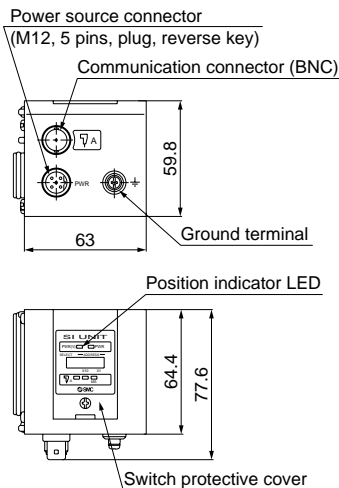

EX250-SEN1 (EtherNet/IP)

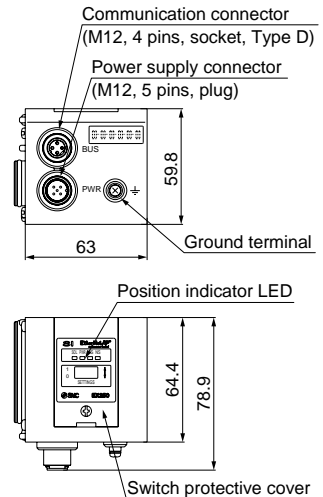

AS-i

EX250-SAS7/9 (1 power supply system)

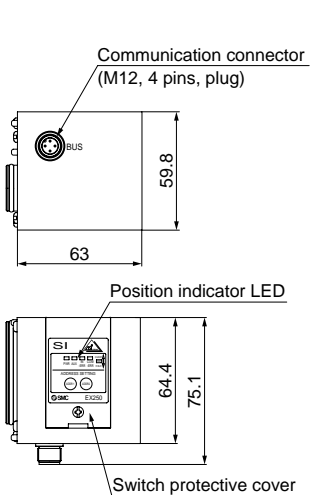

EX250-SAS3/5 (2 power supply system)

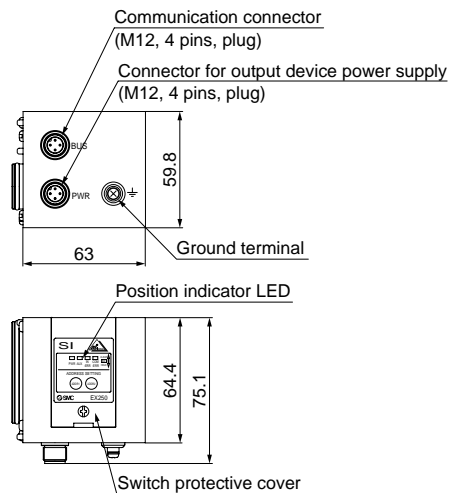

⚠ Specific Product Precautions

Be sure to read this before handling. Please consult with SMC for applications outside the specifications.

When one AS-i power supply system is used

⚠ Caution

		EX250-SAS7	EX250-SAS9
Power supply voltage		Supplied from AS-i circuit, 26.5 to 31.6 VDC ^{Note 1)}	
Internal current consumption		Max. 100 mA	Max. 65 mA
Input/output specification	Number of inputs	8	4
	Number of outputs	8	4
	Supply voltage	24 VDC	
	Supply current ^{Note 2)}	Max. 240 mA	Max. 120 mA

Note 1) For communication power supply, use a power supply dedicated to AS-i. For details, please refer to instruction manuals provided by the respective manufacturers.

Note 2) The AS-i circuit provides current to the internal parts of the SI unit and all connected equipment. Since there is a limit on the possible supply current to all connected equipment, select the equipment connected to the input/output device to stay within the possible supply current.

Example) When EX250-SAS9 is used

Valve: VQC1100NY – 5 (low-wattage type of 0.5 W) x 4 pcs.

$$0.5 \text{ [W]} \div 24 \text{ [V]} \times 4 \text{ [pcs.]} = 84 \text{ [mA]} \text{ (4 outputs simultaneously ON)}$$

The maximum possible supply current of EX250-SAS9 is 120 mA. Therefore, the possible supply current to the sensor is

$$120 \text{ [mA]} - 84 \text{ [mA]} = 36 \text{ [mA]}$$

Use of low-wattage type valves by minimising the maximum number of simultaneous outputs, and low current consumption sensors (2-wire sensor, etc.) is recommended.

Maximum number of AS-i compatible input blocks

SI unit specifications		Input block type		Input block maximum stations
EX250-SAS3	AS-i 8in/8out 31SlaveMode, 2 power supply system	1	M12/2 inputs	4 stations
		2	M12/4 inputs	2 stations
		3	M8/4 inputs	2 stations
EX250-SAS5	AS-i 4in/4out 31SlaveMode, 2 power supply system	1	M12/2 inputs	2 stations
		2	M12/4 inputs	1 station
		3	M8/4 inputs	1 station
EX250-SAS7	AS-i 8in/8out 31SlaveMode, 1 power supply system	1	M12/2 inputs	4 stations
		2	M12/4 inputs	2 stations
		3	M8/4 inputs	2 stations
EX250-SAS9	AS-i 4in/4out 31SlaveMode, 1 power supply system	1	M12/2 inputs	2 stations
		2	M12/4 inputs	1 station
		3	M8/4 inputs	1 station

Series EX250

How to Order Input Blocks

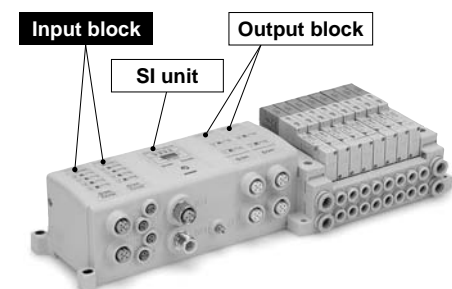
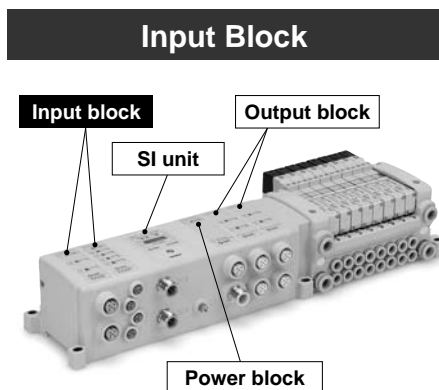

EX250-IE 1

Block type

1	M12 connector, 2 inputs
2	M12 connector, 4 inputs
3	M8 connector, 4 inputs

For options, refer to page 16.

Input Block Specifications

Model		EX250-IE1	EX250-IE2	EX250-IE3
Input specification	Input type	PNP/NPN input (switched using a switch)		
	Number of inputs	2 points	4 points	
	Input device supply voltage	24 VDC		
	Input device supply current	Max. 30 mA/point ^{Note 1)}		
	Rated input current	Approx. 8 mA		
	Display	Green LED (Illuminated when the power supply for the SI unit input is applied), Yellow LED (Illuminated when the input signal is turned on.)		
	Connector on the input device side	M12 connector (4 pins, plug or 5 pins, plug)		M8 connector (3 pins, plug)
Environmental resistance	Enclosure	IP67		
	Operating temperature range	Operating: 5 to 45°C Stored: -20 to 60°C (with no freezing and condensation)		
	Operating humidity range	Operating, Stored: 35 to 85%RH (with no condensation)		
	Withstand voltage	500 VAC for 1 min. between whole charging part and case		
	Insulation resistance	10 MΩ or more (500 VDC Mega) between whole charging part and case		
	Vibration resistance	10 to 150 Hz with a 0.7 mm amplitude or 50 m/s ² in each X, Y, Z direction for 2 hrs (De-energised)		
	Impact resistance	150 m/s ² , in each X, Y, Z direction, 3 times (De-energised)		
Standard		CE marking, UL (CSA)		
Weight		90 g		
Accessory	Tie-rod ^{Note 2)}	2 pcs.		

Note 1) When the maximum inputs for the SI unit is reached by adding an input block, pay attention not to exceed the supply current for the SI unit input.

Note 2) When an input block is integrated into a manifold, its tie-rods are also incorporated at the time of shipping.

Input Block Dimensions / Parts Description

EX250-IE1, EX250-IE2

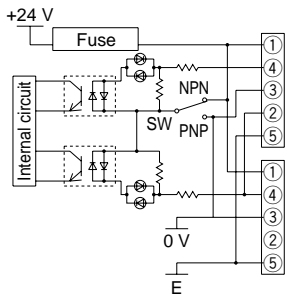

Circuit diagram: EX250-IE1

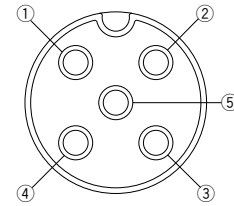
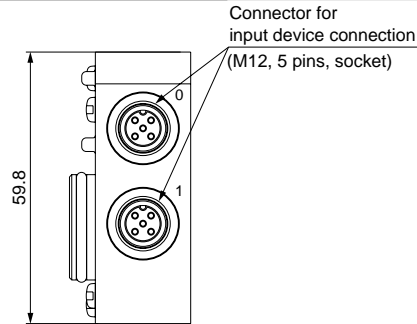

Connector's pin assignment for the input device connection (M12, 5 pins, socket)

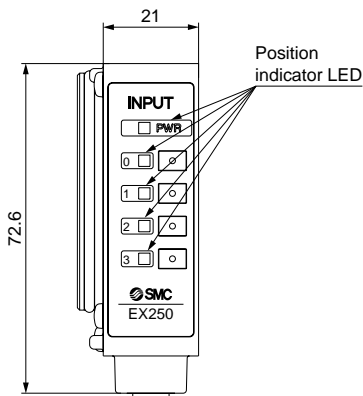

EX250-IE2

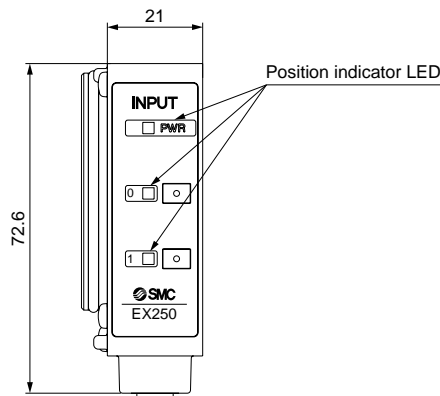

EX250-IE1

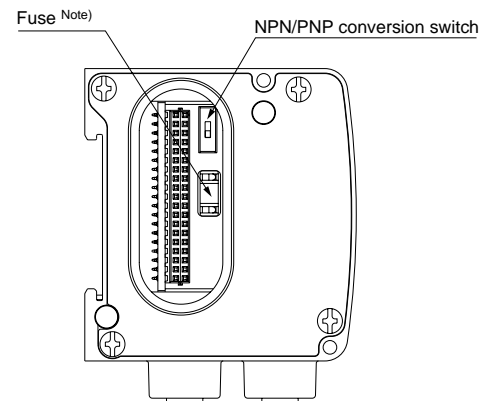

EX250-IE3

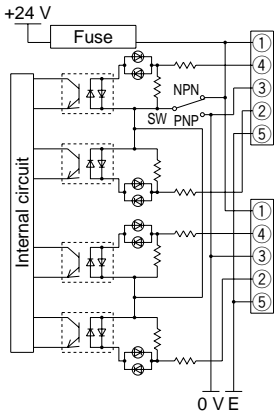

Circuit diagram: EX250-IE2

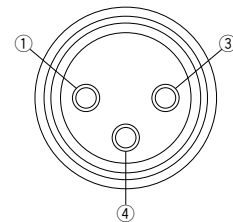
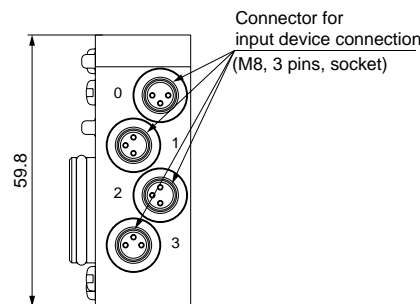

Connector's pin assignment for the input device connection (M8, 3 pins, socket)

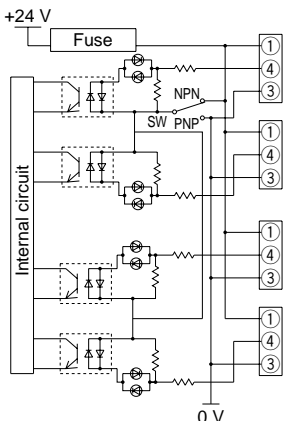

Circuit diagram: EX250-IE3

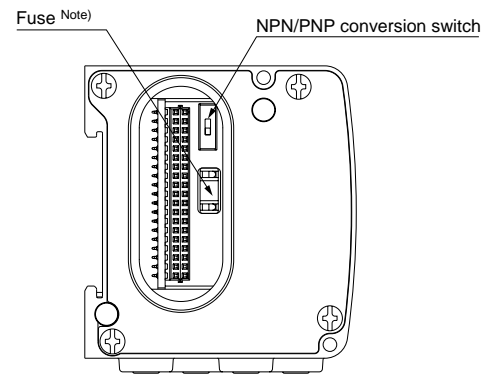
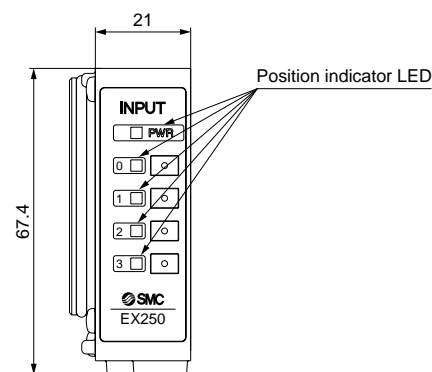

Note) Fuse for overcurrent protection.

When the fuse is blown, after addressing the possible cause of the problem, it can be replaced with a fuse as shown in options, page 19.

Series EX250

Options

Example of connections

Connection example of the SI unit compliant with DeviceNet

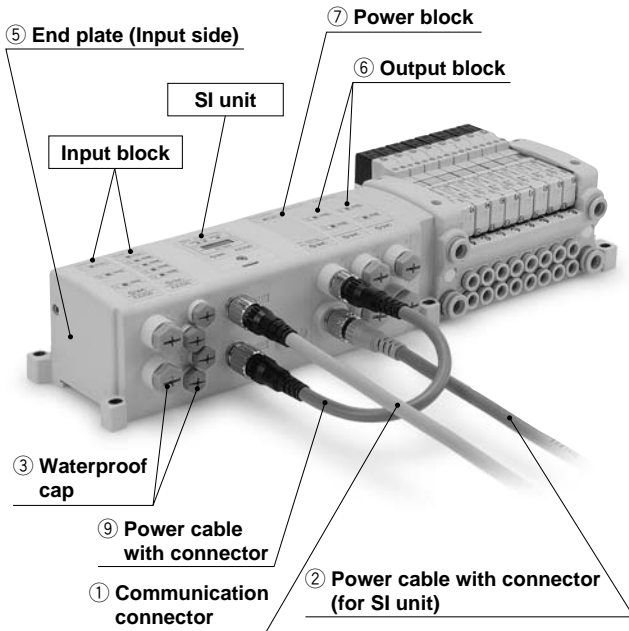

Connection example of the SI unit compliant with EtherNet/IP

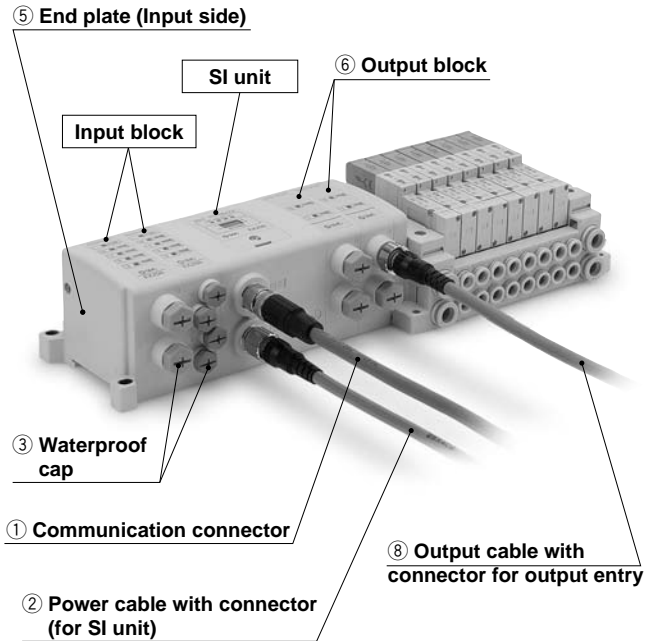

Connection example of the SI unit compliant with AS-i

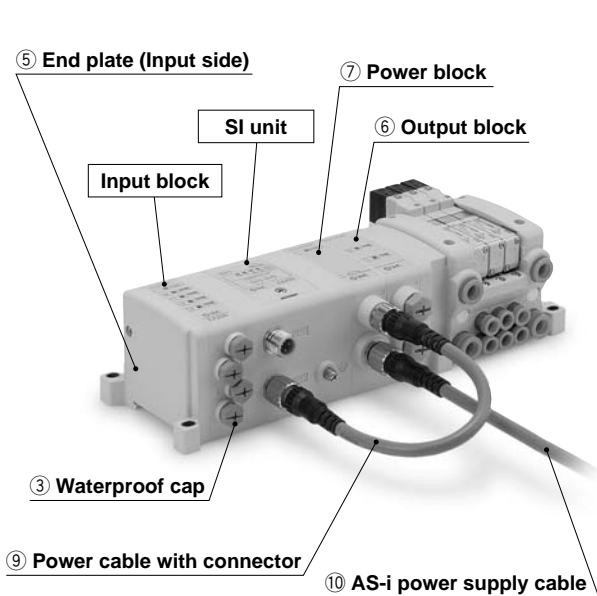

Connection example of the SI unit compliant with PROFIBUS-DP

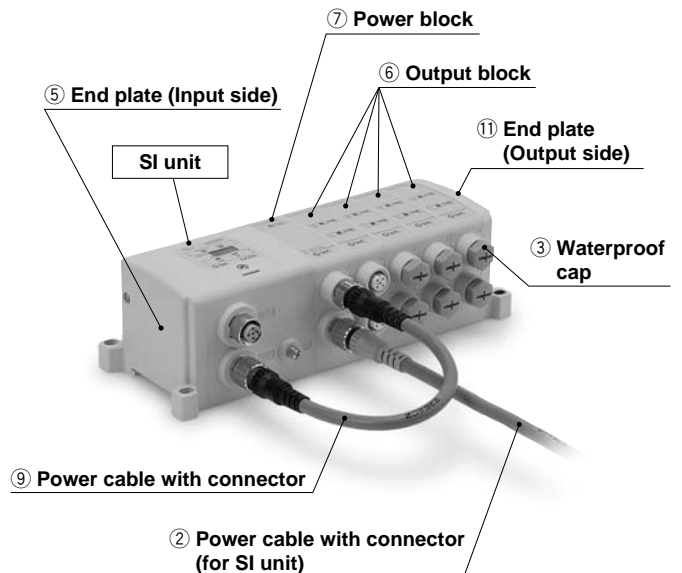

① Communication connector

For DeviceNet type SI unit

EX500-AC 050-DN

Cable length (ℓ)

010	1000 [mm]
050	5000 [mm]

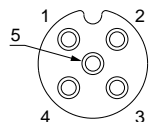
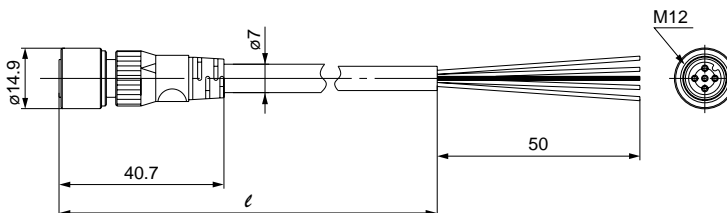

Socket connector pin arrangement

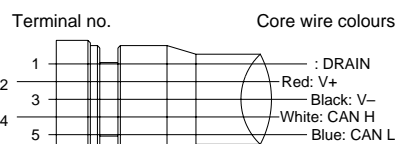

Connections

For EtherNet/IP type SI unit

EX9-AC 020 EN-PSRJ

Cable length (ℓ)

020	2000 [mm]
------------	-----------

Connector specification

PSRJ M12 plug (straight)⇔RJ-45 connector

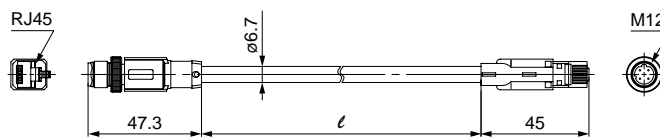

Plug connector pin arrangement

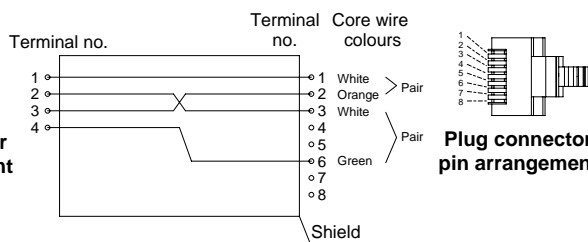

Connections (Straight cable)

Plug connector pin arrangement

Series EX250

Options

② Power cable with connector (for SI unit)

For PROFIBUS-DP, EtherNet/IP type SI unit

EX500 – AP 050 – S

Cable length (ℓ)

010	1000 [mm]
050	5000 [mm]

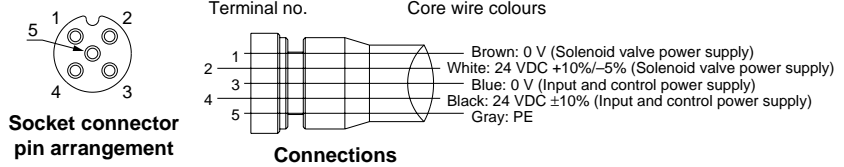
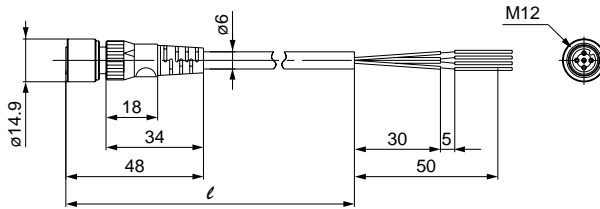

For the SI unit (except for PROFIBUS-DP, AS-i, EtherNet/IP) and power block

EX9 – AC 050 – 1

Cable length (ℓ)

010	1000 [mm]
030	3000 [mm]
050	5000 [mm]

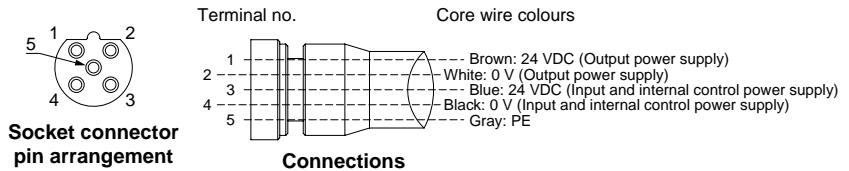
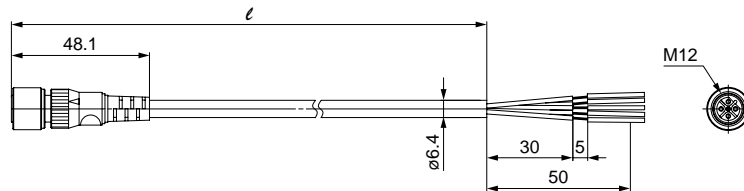

③ Waterproof cap: M8, M12 connector (for socket)

Use this on M8 and M12 connectors (socket) ports that are not being used.
Use of this waterproof cap maintains the integrity of the IP65 enclosure.

Note) Tighten the waterproof cap with the prescribed tightening torque. (For M8: 0.05 N·m, For M12: 0.1 N·m)

EX500 – AW

Connector type

ES	M8 connector (for socket), 10 pcs.
TS	M12 connector (for socket), 10 pcs.

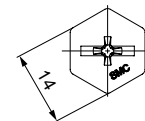
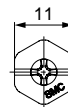
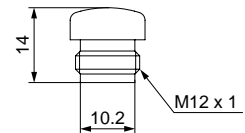
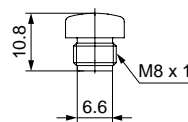

M8 connector (for socket)

M12 connector (for socket)

④ Replacement fuse

Replacement fuse for when the fuse in the input block (EX250-IE□) for overcurrent protection is blown.

EX9 – FU05

Model	EX9-FU05
Applicable model	EX250-IE□
Rated current	0.5 A
Rated insulation capacity	48 VAC/DC 50 A
Fuse resistance value	0.36 Ω

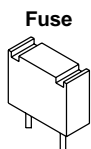

⑤ End plate (Input side)

EX250 – EA 1

EX250-EA1

● Mounting specification

1	Direct mounting
2	DIN rail mounting

Accessory
Hexagon socket head cap screw (M3 x 10): 2 pcs.

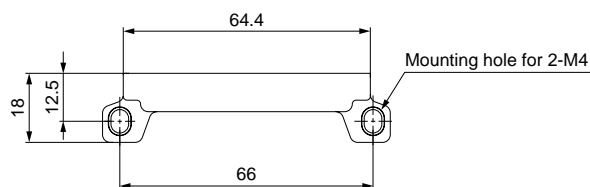
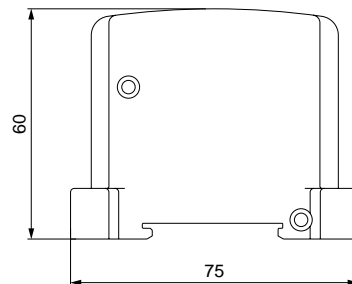
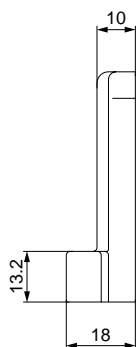

EX250-EA2

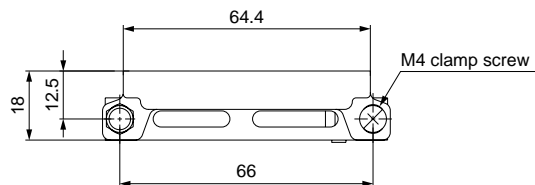
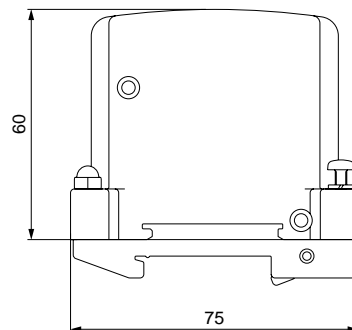
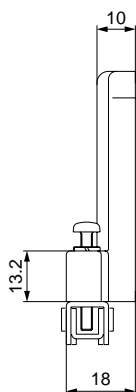

Series EX250

Options

⑥ Output block / ⑦ Power block

- Features:
- Able to retrofit to the valve manifold, using the unused points.
 - 2-output (M12 connector)
 - + common / – common are standardised.
 - Able to drive by 0.5 A per point.

Output block

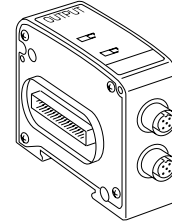

Power block

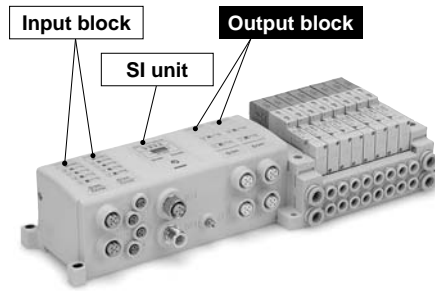
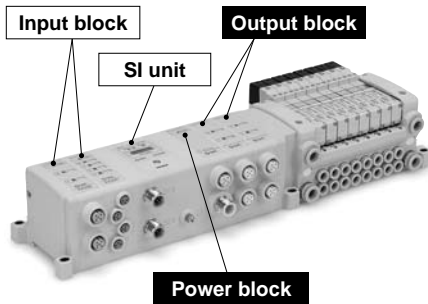
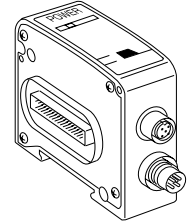

How to Order Output Block

EX9 – OET 1

- Output specification

1	PNP output (–COM.)
2	NPN output (+COM.)
 - Power supply type

T	Internal power supply method (for low-wattage load)
P	Integrated power supply method (for high-wattage load) <small>Note</small>
- Note) Required to connect with a power block.

SI Unit Part No.

SI unit part no.	Output	Applicable model
EX250-SDN1 EX250-SPR1 EX250-SAS□ EX250-SCA1A EX250-SCN1 EX250-SEN1	–COM.	EX9-OET1 EX9-OEP1
EX250-SMJ2	+COM.	EX9-OET2 EX9-OEP2

How to Order Power Block

EX9 – PE1

Option/Part No.

Description	Part no.	Note
Waterproof cap	EX500-AWTS	Refer to page 18. Order separately: 10 pcs. included
Power cable with connector	EX9-AC□-1	Refer to page 18, Order separately.
Cable with connector for between SI unit and power block	EX9-AC002-2 EX9-AC002-3 EX9-AC002-4	Refer to page 23, Order separately.
AS-i power supply cable	EX9-AC□-5	Refer to page 24, Order separately.

Option/Part No.

Description	Part no.	Applicable model		Note
		OET□	OEP□	
Waterproof cap	EX500-AWTS	○	○	Refer to page 18. Order separately: 10 pcs. included
Cable with connector for output entry	EX9-AC□-7	○	○	Refer to page 23. Order separately.
Power block	EX9-PE1		○	Refer to page 20. Order separately.

Output Block Specifications

Model		EX9-OET1	EX9-OET2	EX9-OEP1	EX9-OEP2
Output connector		M12 connector (5 pins)			
Internal current consumption		40 mA or less			
Output specification	Output type	PNP output (-COM.)	NPN output (+COM.)	PNP output (-COM.)	NPN output (+COM.)
	Number of outputs	2 points			
	Power supply method	Internal power supply method		Integrated power supply method (Power block: supplied from EX9-PE1)	
	Output device supply voltage	24 VDC			
	Output device supply current	Max. 62 mA/point (1.5 W/point)		Max. 0.5 A/point (12 W/point)	
	Display	Yellow LED (Lights when power is turned ON.)			
	Connector on the output device side	M12 connector (5 pins, plug)			
Environmental resistance	Enclosure	IP67			
	Operating temperature range	Operating: 5 to 45°C Stored: -20 to 60°C (with no freezing and condensation)			
	Operating humidity range	Operating, Stored: 35 to 85%RH (with no condensation)			
	Withstand voltage	1500 VAC for 1 min. between whole charging part and case			
	Insulation resistance	10 MΩ or more (500 VDC Mega) between whole charging part and case			
	Vibration resistance	10 to 150 Hz with a 0.7 mm amplitude or 50 m/s ² in each X, Y, Z direction for 2 hrs (De-energised)			
	Impact resistance	100 m/s ² in each X, Y, Z direction, 3 times (De-energised)			
Standard		CE marking, UL (CSA)			
Weight		120 g			
Accessory	Tie-rod	2 pcs.			

Power Block Specifications

Model		EX9-PE1
Connection block		Output block (EX9-OEP□)
Connection block stations		Output block: Max. 9 stations (excluding input blocks) ^{Note)}
Power supply for output and internal control	Power supply voltage	22.8 to 26.4 VDC
	Internal power consumption	20 mA or less
Supply current		Max. 3.1 A (When using with 3.0 to 3.1 A, the ambient temperature should not exceed 40°C, and do not bundle the cable.)
Environmental resistance	Enclosure	IP67
	Operating temperature range	Operating: 5 to 45°C Stored: -20 to 60°C (with no freezing and condensation)
	Operating humidity range	Operating, Stored: 35 to 85%RH (with no condensation)
	Withstand voltage	1500 VAC for 1 min. between whole charging part and case
	Insulation resistance	10 MΩ or more (500 VDC Mega) between whole charging part and case
	Vibration resistance	10 to 150 Hz with a 0.7 mm amplitude or 50 m/s ² in each X, Y, Z direction for 2 hrs (De-energised)
	Impact resistance	100 m/s ² in each X, Y, Z direction, 3 times (De-energised)
Standard		CE marking, UL (CSA)
Weight		120 g
Accessory	Tie-rod	2 pcs.
	Waterproof cap (for M12 connector socket)	1 pc. (EX500-AWTS)

Note) The total number of connectable input/output/power block to the EX250 series SI unit (except for AS-i compliant) is 10 stations at the maximum.

Series EX250

Options

Output Block Dimension

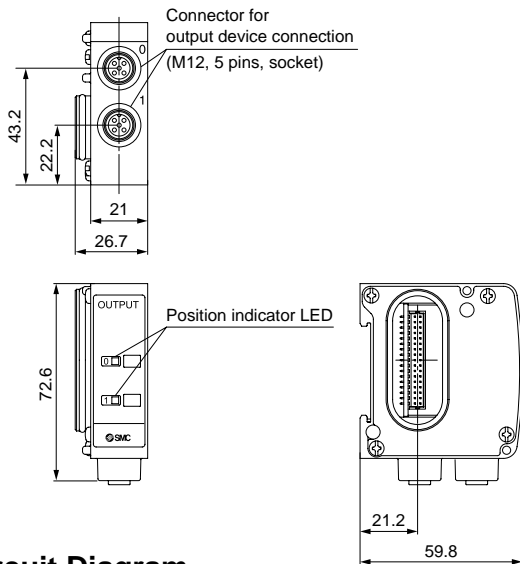

Power Block Dimension

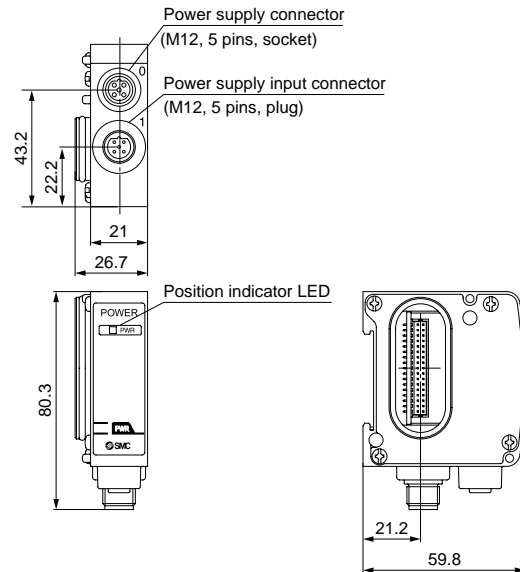

Circuit Diagram

EX9-OET1

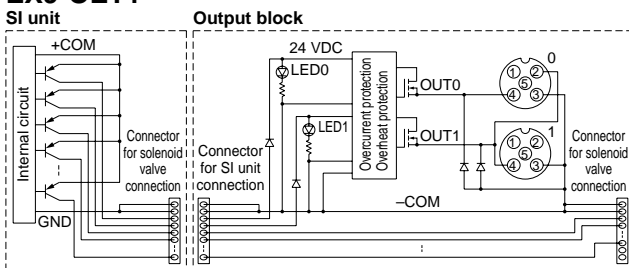

EX9-OET2

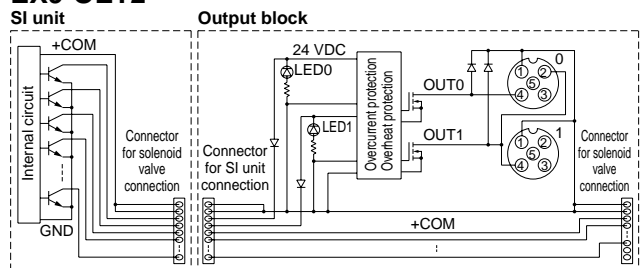

EX9-OEP1

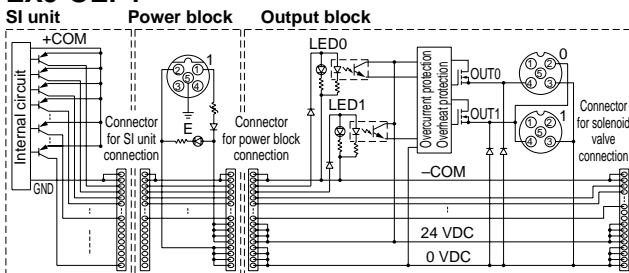

EX9-OEP2

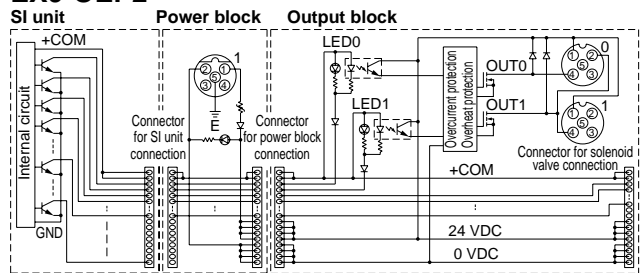

EX9-PE1

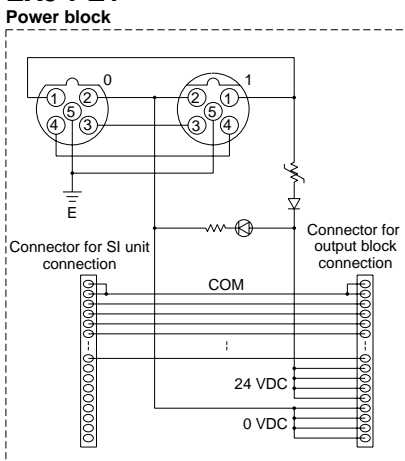

We sell this product individually. Please place an order separately. You are requested to connect it to an SI unit and a valve manifold. When using the output block only (valve manifold is unused.), please place an order for an end plate (① EX9-EA□) separately for connection. Refer to the separate technical instruction manual for connection, wiring, installation, optional goods and cable, etc.

⑧ Output cable with connector

EX9-AC030-7

Cable length (l)

010	1000 [mm]
030	3000 [mm]

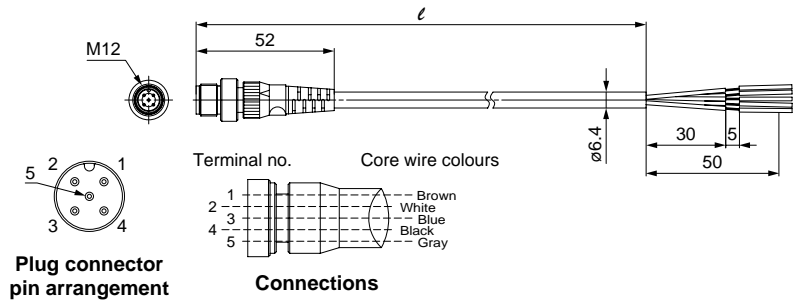

Note) Wiring to the output devices differs depending on the output style of the output block.
For details, please refer to the technical documentation for the output block.

⑨ Power cable with connector

Connects between the power supply connector for the power block and the SI unit power supply connector, bridging the external power supply, which is supplied with the power block, to the SI unit.

EX9-AC002-2

SI unit type

2	EX250-SDN1	} Compliant
	EX250-SMJ2	
	EX250-SCA1A	
	EX250-SCN1	
3	EX250-SPR1	} Compliant
	EX250-SEN1	
4	EX250-SAS3/5	Compliant

EX9-AC002-2

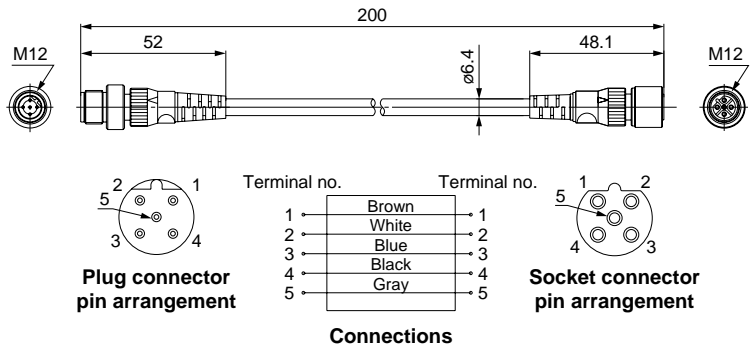

EX9-AC002-3

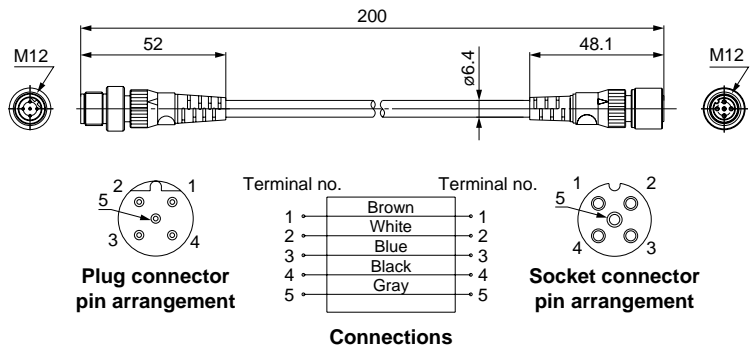

EX9-AC002-4

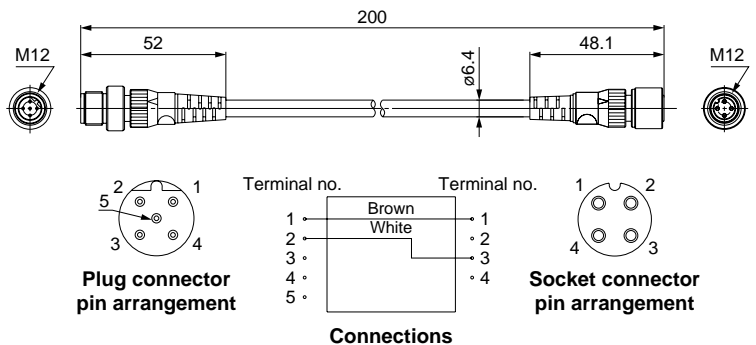

Series EX250

Options

⑩ AS-i power cable

Cable connecting between AS-i power supply line (for external devices) branch connector (M12) and the power block's power supply input connector.

EX9-AC010-5

Cable length (ℓ)

010	1000 [mm]
030	3000 [mm]
050	5000 [mm]

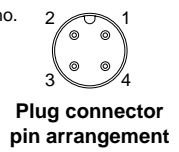
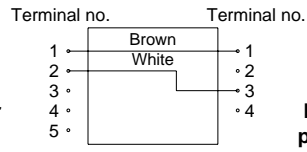
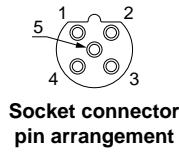
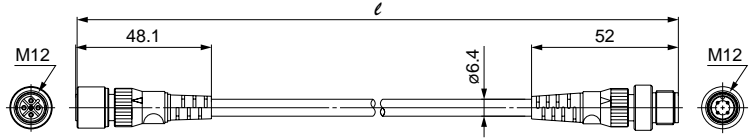

Connections

⑪ End plate (Output side)

The plate connected on the output block side in order to connect or fix between the SI unit and the input/output/power block when the valve manifold is not used.

EX9-EA03

Mounting specification

03	Direct mounting
04	DIN rail mounting

EX9-EA03

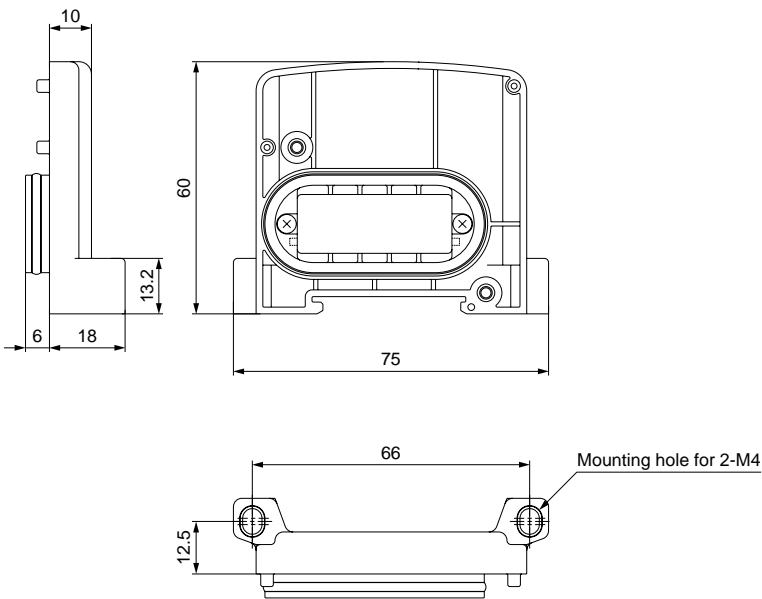

EX9-EA04

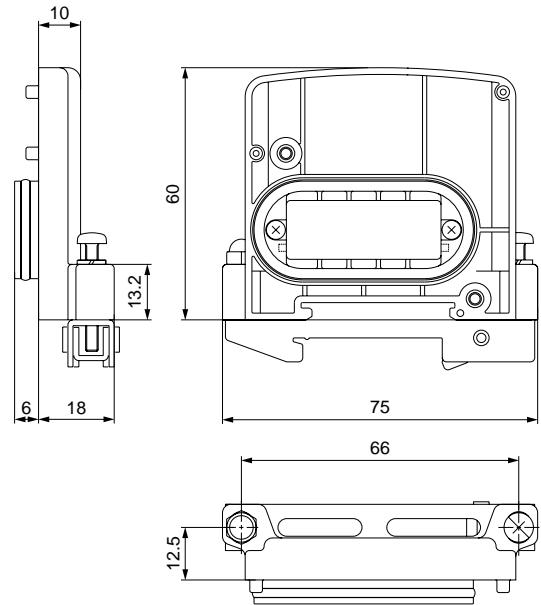

How to Increase Input/Output Blocks, Procedure Drawing

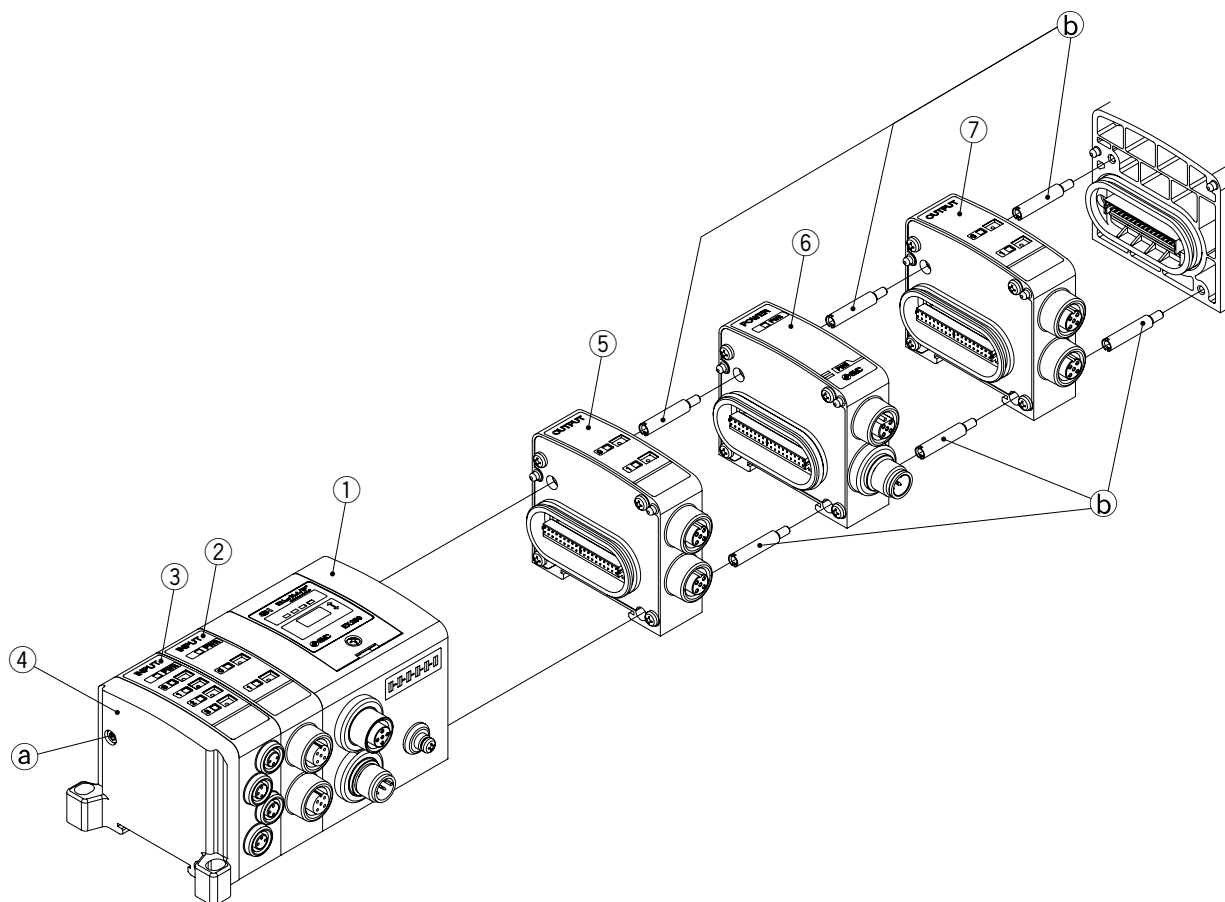

Parts List

No.	Description	Part no.	Note
1	SI unit	EX250-S□	For details, refer to page 10.
2	Input block (M12, 2 inputs)	EX250-IE1	PNP/NPN switchable
3	Input block (M8, 4 inputs)	EX250-IE3	PNP/NPN switchable
4	End plate (Input side)	EX250-EA1	EA2: DIN rail mounting
5	Output block (For low-wattage load)	EX9-OET□	1: PNP output, 2: NPN output
6	Power block	EX9-PE1	For EX9-OEP□
7	Output block (For high-wattage load)	EX9-OEP□	1: PNP output, 2: NPN output

How to increase the input block, and output block (power block)

- ① Loosen the hexagon socket head cap screws ① (2 locations) which are fixing the end plate of the valve manifold.
- ② Separate the section to be installed additionally.
- ③ Add and increase the attached tie-rod ② (2 pcs per block) to the increased block respectively and pass through a block by the tie-rod.

Increased section: Input block Between the left side of the SI unit and the end plate
 Output (power) block Between the right side of the SI unit and the valve

- ④ Fix by loosening the hexagon socket head cap screw ①, paying attention to avoid the gap between each block.

* In the case of the DIN rail manifold, prepare the DIN rail long enough to ensure the extended length, because the length of the manifold is increased by a 21 mm per block addition. Please contact SMC for the DIN rail's part number and its specifications.



EUROPEAN SUBSIDIARIES:



Austria

SMC Pneumatik GmbH (Austria).
Girakstrasse 8, A-2100 Korneuburg
Phone: +43 2262-62280, Fax: +43 2262-62285
E-mail: office@smc.at
http://www.smc.at



Belgium

SMC Pneumatics N.V./S.A.
Nijverheidsstraat 20, B-2160 Wommelgem
Phone: +32 (0)3-355-1464, Fax: +32 (0)3-355-1466
E-mail: post@smcpneumatics.be
http://www.smcpneumatics.be



Bulgaria

SMC Industrial Automation Bulgaria EOOD
16 Kliment Ohridski Blvd., fl.13 BG-1756 Sofia
Phone: +385 1 377 66 74, Fax: +359 2 9744519
E-mail: office@smc.bg
http://www.smc.bg



Croatia

SMC Industrijska automatika d.o.o.
Cromerec 12, 10000 ZAGREB
Phone: +420 5 414 24611, Fax: +385 1 377 66 74
E-mail: office@smc.hr
http://www.smc.hr



Czech Republic

SMC Industrial Automation CZ s.r.o.
Hudcova 78a, CZ-61200 Brno
Phone: +420 5 414 24611, Fax: +420 5 412 18034
E-mail: office@smc.cz
http://www.smc.cz



Denmark

SMC Pneumatik A/S
Knudsminde 4B, DK-8300 Odder
Phone: +45 70252900, Fax: +45 70252901
E-mail: smc@smc-pneumatik.dk
http://www.smc.dk.com



Estonia

SMC Pneumatics Estonia OÜ
Laki 12-101, 106 21 Tallinn
Phone: +372 (0)6 593540, Fax: +372 (0)6 593541
E-mail: smc@smcpneumatics.ee
http://www.smcpneumatics.ee



Finland

SMC Pneumatics Finland Oy
PL72, Tiistiniityntie 4, SF-02031 ESPOO
Phone: +358 207 513513, Fax: +358 207 513595
E-mail: smcfi@smc.fi
http://www.smc.fi



France

SMC Pneumatique, S.A.
1, Boulevard de Strasbourg, Parc Gustave Eiffel
Bussy Saint Georges F-77607 Marne La Vallée Cedex 3
Phone: +33 (0)1-6476 1000, Fax: +33 (0)1-6476 1010
E-mail: contact@smc-france.fr
http://www.smc-france.fr



Germany

SMC Pneumatik GmbH
Boschring 13-15, D-63329 Egelsbach
Phone: +49 (0)6103-4020, Fax: +49 (0)6103-402139
E-mail: info@smc-pneumatik.de
http://www.smc-pneumatik.de



Greece

SMC Hellas EPE
Anagniniseos 7-9 - P.C. 14342, N. Philadelphia, Athens, Greece
Phone: +30-210-2717265, Fax: +30-210-2717766
E-mail: sales@smchellas.gr
http://www.smchellas.gr



Hungary

SMC Hungary Ipari Automatizálási Kft.
Budafoki út 107-113, H-1117 Budapest
Phone: +36 1 371 1343, Fax: +36 1 371 1344
E-mail: office@smc.hu
http://www.smc.hu



Ireland

SMC Pneumatics (Ireland) Ltd.
2002 Citywest Business Campus, Naas Road, Saggart, Co. Dublin
Phone: +353 (0)1-403 9000, Fax: +353 (0)1-464-0500
E-mail: sales@smcpneumatics.ie
http://www.smcpneumatics.ie



Italy

SMC Italia S.p.A
Via Garibaldi 62, I-20061 Carugate, (Milano)
Phone: +39 (0)2-92711, Fax: +39 (0)2-9271365
E-mail: mailbox@smcitalia.it
http://www.smcitalia.it



Latvia

SMC Pneumatics Latvia SIA
Smerla 1-705, Riga LV-1006, Latvia
Phone: +371 781-77-00, Fax: +371 781-77-01
E-mail: info@smclv.lv
http://www.smclv.lv



Lithuania

SMC Pneumatics Lietuva, UAB
Savanoriu pr. 180, LT-01354 Vilnius, Lithuania
Phone: +370 5 264 81 26, Fax: +370 5 264 81 26



Netherlands

SMC Pneumatics BV
De Ruyterkade 120, NL-1011 AB Amsterdam
Phone: +31 (0)20-5318888, Fax: +31 (0)20-5318880
E-mail: info@smcpneumatics.nl
http://www.smcpneumatics.nl



Norway

SMC Pneumatics Norway A/S
Vollsveien 13 C, Granfos Næringspark N-1366 Lysaker
Tel: +47 67 12 90 20, Fax: +47 67 12 90 21
E-mail: post@smc-norge.no
http://www.smc-norge.no



Poland

SMC Industrial Automation Polska Sp.z.o.o.
ul. Konstruktorska 11A, PL-02-673 Warszawa,
Phone: +48 22 548 5085, Fax: +48 22 548 5087
E-mail: office@smc.pl
http://www.smc.pl



Portugal

SMC Sucursal Portugal, S.A.
Rua de Engº Ferreira Dias 452, 4100-246 Porto
Phone: +351 22-610-89-22, Fax: +351 22-610-89-36
E-mail: postpt@smc.smces.es
http://www.smces.es



Romania

SMC Romania srl
Str Frunzei 29, Sector 2, Bucharest
Phone: +40 213205111, Fax: +40 213261489
E-mail: smcromania@smcromania.ro
http://www.smcromania.ro



Russia

SMC Pneumatik LLC.
4B Sverdlovskaja nab, St. Petersburg 195009
Phone: +812 718 5445, Fax: +812 718 5449
E-mail: info@smc-pneumatik.ru
http://www.smc-pneumatik.ru



Slovakia

SMC Priemyselna Automatizacia, s.r.o.
Námestie Martina Benku 10, SK-81107 Bratislava
Phone: +421 2 444 56725, Fax: +421 2 444 56028
E-mail: office@smc.sk
http://www.smc.sk



Slovenia

SMC industrijska Avtomatika d.o.o.
Grajski trg 15, SLO-8360 Zuzemberk
Phone: +386 738 85240 Fax: +386 738 85249
E-mail: office@smc.si
http://www.smc.si



Spain

SMC España, S.A.
Zuazobidea 14, 01015 Vitoria
Phone: +34 945-184 100, Fax: +34 945-184 124
E-mail: post@smc.smces.es
http://www.smces.es



Sweden

SMC Pneumatics Sweden AB
Ekhagsvägen 29-31, S-141 71 Huddinge
Phone: +46 (0)8-603 12 00, Fax: +46 (0)8-603 12 90
E-mail: post@smcpneumatics.se
http://www.smc.nu



Switzerland

SMC Pneumatik AG
Dorfstrasse 7, CH-8484 Weisslingen
Phone: +41 (0)52-396-3131, Fax: +41 (0)52-396-3191
E-mail: info@smc.ch
http://www.smc.ch



Turkey

Entek Pnömatik San. ve Tic.Ltd. Sti.
Perpa Tic. Merkezi Kat: 11 No: 1625, TR-80270 Okmeydanı Istanbul
Phone: +90 (0)212-221-1512, Fax: +90 (0)212-221-1519
E-mail: smc-entek@entek.com.tr
http://www.entek.com.tr



UK

SMC Pneumatics (UK) Ltd
Vincent Avenue, Crownhill, Milton Keynes, MK8 0AN
Phone: +44 (0)800 1382930 Fax: +44 (0)1908-555064
E-mail: sales@smcpneumatics.co.uk
http://www.smcpneumatics.co.uk



OTHER SUBSIDIARIES WORLDWIDE:

ARGENTINA, AUSTRALIA, BOLIVIA, BRASIL, CANADA, CHILE,
CHINA, HONG KONG, INDIA, INDONESIA, MALAYSIA, MEXICO,
NEW ZEALAND, PHILIPPINES, SINGAPORE, SOUTH KOREA,
TAIWAN, THAILAND, USA, VENEZUELA

<http://www.smceu.com>
<http://www.smcworld.com>