

UNICONT PM

PMG-500
UNIVERSAL CONTROLLER

USER'S AND PROGRAMMING MANUAL
4th edition



PDF 



Manufacturer:

NIVELCO

Process Control Co.

H-1043 Budapest, Dugonics u. 11. ■ Tel.: +36-1-889-0100

E-mail: sales@nivelco.com ■ nivelco.com



1. INTRODUCTION	4
2. SPECIFICATIONS	4
2.1 General Data	4
2.2 Accessories	5
2.3 Order Code	5
2.4 Outlines and Dimensions	6
3. MOUNTING	6
4. WIRING	7
5. PROGRAMMING	7
5.1 Parts and Display	7
5.2 Startup	9
5.3 Input Settings [PAR3 → IN-T]	9
5.3.1 Input Types [PAR3 → IN-T]	9
5.3.2 Sensor Temperature Unit	10
5.3.3 Analog Input Scale Value Settings	10
5.3.4 Low-Limit Input Value [PAR3 → L-RG]	11
5.3.5 Upper-Limit Input Value [PAR3 → H-RG]	11
5.3.6 Scale Decimal Point Position [PAR3 → DOT]	11
5.3.7 Lower Limit Scale Value [PAR3 → L-SC]	11
5.3.8 Upper Limit Scale Value [PAR3 → H-SC]	11
5.3.9 Input Offset Correction [PAR3 → IN-B]	11
5.3.10 Input Digital Filter [PAR3 → MAVF]	12
5.3.11 Upper Limit [PAR3 → H-SV] and Lower Limit of Set Value (SV) [PAR3 → L-SV]	12
5.4 Output Settings	12
5.4.1 Control output (OUT1/OUT2) selection [PAR3 → OUT1/OUT2]	12
5.4.2 SSRP function [PAR3 → O1SR/O2SR]	12
5.4.3 Current output range settings [PAR3 → O1MA/O2MA]	13
5.5 Control Output	13
5.5.1 Heating Control [PAR3 → O-FT → HEAT] or Cooling Control [PAR3 → O-FT → COOL]	14
5.5.2 Heating & Cooling Control [PAR3 → O-FT → H-C]	14
5.5.3 Deadband/Overlap Band [PAR2 → DB]	15
5.5.4 MV Upper Limit Value [PAR2 → H-MV] and MV Lower Limit Value [PAR2 → L-MV]	18
5.5.5 MV Settings for Sensor Break Error [OPEN] [PAR5 → ErMV]	18
5.5.6 Ramp Settings [PAR2 → RAMU/ RAMD/ rUNT]	18
5.5.7 Auto/Manual control settings	19
5.5.7.1 Switching Between Manual/Auto Control	19
5.5.7.2 Initial MV for Manual Control [PAR5 → IIMV]	21
5.5.7.3 Initial MV Manual Control [PAR5 → PrMV]	21
5.6 Temperature Control	21
5.6.1 Temperature Control Mode [PAR3 → C-MD]	21
5.6.2 ON/OFF Control with Hysteresis Function [PAR3 → C-MD → ONOF]	21
5.6.3 PID Control [PAR3 → C-MD → PID]	23
5.6.3.1 Setting the Proportional Band for Heating [PAR2 → H-P] and Cooling [PAR2 → C-P]	24
5.6.3.2 Setting Integral Time for Heating [PAR2 → H-I] and Cooling [PAR2 → C-I]	24
5.6.3.3 Setting Differential Time for Heating [PAR2 → H-D] and Cooling [PAR2 → C-D]	24
5.6.3.4 Setting Control Period for Heating [PAR3 → H-T] and Cooling [PAR3 → C-T]	24
5.6.3.5 Offset Correction / Manual Reset Settings [PAR2 → REST]	24
5.6.4 Auto-Tuning	25
5.6.4.1 Auto-Tuning ON/OFF [PAR2 → AT]	25
5.6.5 Auto-Tuning Mode Settings [PAR3 → AT.t]	25

5.7 Alarm Output	26
5.7.1 Alarm Operation [PAR4 → AL-1]	26
5.7.2 Alarm Output Settings [PAR4 → AL1T]	27
5.7.3 Alarm Output Lower [PAR1 → AL1L] and Upper [PAR1 → AL1H] Limit Value Settings	28
5.7.4 Alarm Output Hysteresis [PAR4 → A1HY]	28
5.7.5 Alarm N.O./N.C. [PAR4 → A1N]	29
5.7.6 Alarm Output Delay Settings [PAR4 → A1ON / A1OF]	29
5.7.7 Loop Break Alarm (LBA) [PAR4 → AL-1/ → LBA]	29
5.7.8 LBA Monitoring Period [PAR4 → LBA _T]	30
5.7.9 LBA Detection Band [PAR4 → LBA _B]	30
5.7.10 Sensor Break Alarm [PAR4 → AL-1 → SBA]	32
5.7.11 Heater Burnout Alarm [PAR4 → AL-1 → HBA]	32
5.7.12 Alarm Output Deactivation [PAR5 → DI-K → ALRE]	33
5.7.13 Alarm Output Examples	34
5.8 Analog Transmission	35
5.8.1 Analog Transmission Output Value Settings [PAR4 → AoM1]	35
5.8.2 Transmission Output Upper / Lower Limit Value Settings [PAR4 → FsL1/ FsH1]	35
5.9 Communication	35
5.9.1 Unit Address Settings [PAR4 → ADRS]	36
5.9.2 BPS (Bits Per Second) Settings [PAR4 → BPS]	36
5.9.3 Communication Parity Bit [PAR4 → PRTY]	36
5.9.4 Communication Stop Bit Settings [PAR4 → STP]	36
5.9.5 Response Timeout Settings [PAR4 → RSWT]	36
5.9.6 Enable / Disable Communication Writing [PAR4 → COMW]	37
5.10 Other Functions	37
5.10.1 Heating MV Monitoring	37
5.10.2 Cooling MV Monitoring	37
5.10.3 Heating Current Monitoring [PAR1 → CT-A]	37
5.10.4 RUN/STOP [PAR1 → R-S]	37
5.10.4.1 Stop Control Output Settings	37
5.10.4.2 Stopping the Alarm Output [PAR5 → StAL]	38
5.10.5 Multi SV	38
5.10.5.1 The Number of Multi SVs [PAR5 → MtsV]	38
5.10.5.2 Selecting the Multi SV Number [PAR1 → SV-N]	38
5.10.5.3 Multi SV Settings [PAR1 → SV-0/ SV-1]	38
5.10.6 Digital Input	38
5.10.6.1 Digital Input Terminal Settings [PAR5 → DI-1]	38
5.10.6.2 Digital Input Button Setting [PAR5 → DI-K]	39
5.10.7 User Level Settings [PAR5 → USER]	39
5.10.8 SV Group Lock [PAR5 → LcSV]	39
5.10.9 Parameter Group Lock [PAR5 → LcP1/LcP2/LcP3/LcP4/LcP5]	39
5.10.10 Reset Parameter [INIT]	39
5.10.11 Password Settings [PAR5 → PWD]	38
5.10.11.1 Setting up a Password [PASS]	40
5.10.11.2 Reset Password	40
6. ERROR CODES	41
7. MAINTENANCE, REPAIR, AND STORAGE	42
8. MENU MAP	ANNEX

1. INTRODUCTION

In addition to the 1/16 DIN (48 x 48 mm) design, the UNICONT PM universal controller family is characterized by easy setpoint adjustment and easy programming. The universal analog PID controller is suitable for processing signals from Pt100 resistance thermometers, various thermocouples, and transmitters with a 4...20 mA and 0...10 V DC, 0...5 V DC, 1...5 V DC, 0...100 mV DC signal. The control output can be a relay, a continuous 0...20 mA or 4...20 mA current signal, or an output suitable for operating an SSR (*solid-state relay*). The self-learning autotuning (AT) mode helps users determine PID parameters. The device provides automatic wire compensation for the Pt100 input signal and automatic cold junction compensation for the thermocouple input signal. Some PM-500 series members are also capable of RS485 communication.

The UNICONT PM-500 enables more efficient control with a super-fast 50 ms sampling cycle and $\pm 0.3\%$ display accuracy. Moreover, it supports a variety of control modes, including simultaneous control of heating and cooling and automatic/manual control and communication functions.

2. SPECIFICATIONS

2.1 GENERAL DATA

		PMG-500
Power supply	AC	100...240 V AC, 50/60 Hz, 8 VA
	AC/DC	24 V AC 50/60 Hz, 8 VA / 24...48 V DC, 5 W
Voltage tolerance		$\pm 10\%$ deviance from nominal voltage
Ambient temperature		-10...+50 °C (14...122 °F)
Ambient humidity		35...85% RH
Display		Process Value (PV): 7-segment, red, 7.0 × 14.0 mm (0.27 × 0.55"). Set Value (SV): 7-segment, green, 5.0 × 10.0 mm (0.2 × 0.39"). Status LEDs with labels
Primary input	RTD mode	Compatible resistance temperature sensors: JPt 100 Ω, DPt 100 Ω, DPt 50 Ω, Cu 100 Ω, Cu 50 Ω, and Nikel 120 Ω
	TC mode	Compatible thermocouple sensors: K, J, E, T, L, N, U, R, S, B, C, G, and PLII
	Analog mode	Voltage: 0...100 mV, 0...5 V, 1...5 V, 0...10 V Current: 0...20 mA, 4...20 mA
Optional inputs	CT input	0...50 mA (for external 1/1000 CT connection)
	Digital input (DI)	Active input for passive switches, measuring current: 0.5 mA / 5 V Contact switch – sensing threshold: 'On' < 2 kΩ / 'Off' > 90 kΩ Transistor switch – sensing threshold: 'On' < 1.0 V DC / 'Off' < 0.1 mA
Display accuracy	RTD mode	Room temperature (23 °C ± 5 °C): (PV $\pm 0.3\%$ or ± 1 °C) ± 1 digit
	TC mode	Full ambient-temperature range: (PV $\pm 0.5\%$ or ± 2 °C) ± 1 digit
	Analog mode	Room temperature (23 °C ± 5 °C): $\pm 0.3\%$ F.S. ± 1 digit Full ambient-temperature range: $\pm 0.5\%$ F.S. ± 1 digit
	CT input	$\pm 5\%$ F.S. ± 1 digit
Control outputs	Relay (OUT1 / 2)	250 V / 3 A AC-1
	SSR (OUT1 / 2)	11 V DC ± 2 V / 20 mA
	Current (OUT1 / 2)	4...20 mA / 0...20 mA selectable (max. loop resistance 500 Ω)
Alarm output	Relay (AL1)	250 V / 3 AAC-1

Optional outputs	Transmitter output	4...20 mA: output accuracy $\pm 0.3\%$ F.S (max. loop resistance 500 Ω)
	Communication	RS485 communication Modbus RTU protocol
Control algorithms:		ON/OFF, P, PI, PD, PID
Hysteresis		RTD / Thermocouples: 1...100 $^{\circ}\text{C}$ (0.1...100 $^{\circ}\text{C}$)
Proportional band (P)		0.1...999.9 $^{\circ}\text{C}$ (0.1...999.9%)
Integral time (I)		0...9999 s
Differential time (D)		
Control period (T)		Relay output, SSR driver output: 0.1...120.0 s Current loop output + SSR driver output: 1.0...120.0 s
Manual reset value		0...100%
Sampling period		50 ms
Vibration resistance		0.75 mm amplitude at frequency 5 to 55 Hz (for 1 min) in each X, Y, Z direction for 2 hours
Relay life cycle	Mechanical	OUT1/OUT2: min. 5,000,000 operations AL1: min. 20,000,000 operations
	Electrical	OUT1/OUT2, AL1: min. 100,000 operations
Memory retention		~10 years (non-volatile semiconductor memory)
Ingress protection		Behind mounting plane: IP20, front panel: IP54
Insulation type		Reinforced insulation between the input and the power part (dielectric breakdown: 2 kV)
Bounding box size		48 × 48 × 70.5 mm (1.89 × 1.89 × 2.77")
Weight		~105 g (3.7 oz)

2.2 ACCESSORIES

- User's and Programming Manual
- Mounting bracket

- Warranty Card
- EU Declaration of Conformity

2.3 ORDER CODE

UNICONT **P** **M** **G** - **5** **1** - **0**

Input	Output	Code	Supply voltage	Code
1 universal input	R1, R2 relays, Iout, AL1 relay	1	100...200 V AC	1
	R1 relay, SSR1 / 4...20 mA, AL1 relay	2	24 V AC/DC	2
	R1 relay, SSR1 / 4...20 mA, AL1 relay, RS485	3		
	SSR1, SSR2 / 4...20 mA, AL1 relay	4		
	SSR1 / 4...20 mA, SSR2 / 4...20 mA, AL1 relay	5		

Legend:

I_{out} : 0/4...20 mA output, which can be control or transmitter type

SSR1: Solid-state relay driver output

RS485: Series line connection with Modbus RTU protocol

AL1: Closing contact relay output

2.4 OUTLINES AND DIMENSIONS

The device can be mounted in a 48x48 mm cutout (1/16 DIN board instrument).

The insertion depth is 64.5 mm, other main dimensions are shown in the figure.

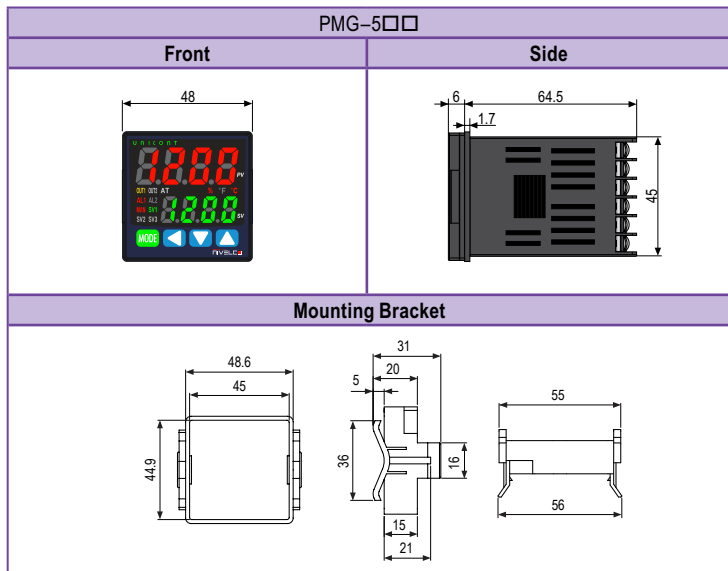

3. MOUNTING

The panel is mounted on the front panel in a 1/16 DIN (48 x 48 mm) cutout with the supplied mounting frame. Make sure that the rubber seal fits, which ensures tightness from the front. When installing multiple instruments, ensure adequate distances. Insert the unit into the bracket panel and secure the bracket with a straight screwdriver

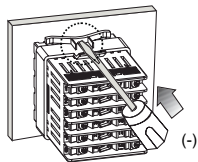

Tightening the mounting bracket

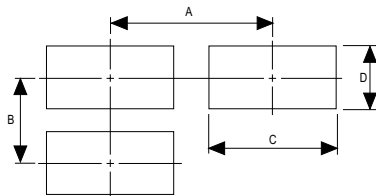

Minimum distance between devices

A – min. 65 mm C – $45^{+0.6}$ mm

B – min. 65 mm D – $45^{+0.6}$ mm

4. WIRING

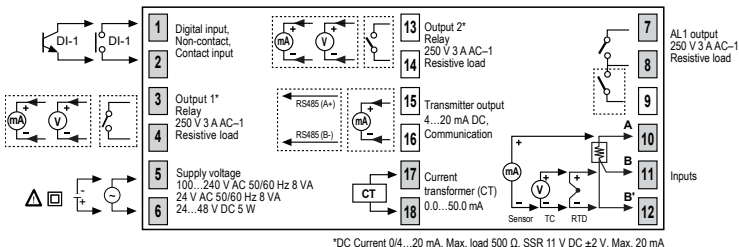

All types have colored connection points. Other connection point types depend on the particular variant.

Important information for proper use:

- The digital input is not electrically isolated from internal circuits, so it must be insulated if it is connected to another circuit.
- Make sure that the connection polarity of the temperature sensor or analog input is correct.
- Make sure the polarity of the power supply is correct.
- Do not swap the output and input terminals.
- For thermocouple sensors, use a compensation cable with the same specifications as the input sensors. Using an extension cord of different specifications and/or materials makes temperature sensing less accurate. For more reliable operation, choosing a high-grade compensation cable is recommended.
- Do not place sensor wires near AC wires.
- Do not attach communication cables to the AC power cord. Use only twisted-pair wires for communication cabling. The length of the communication cable must not exceed 800 meters.

5. PROGRAMMING

5.1 PARTS AND DISPLAY

The seven-segment displays show the measured (*Process Value, PV*) and set values (*SV*) in regular operation, while in other modes, they show the corresponding text signals and values according to the current status of programming and setting. Use the 4 buttons to operate the menu system and perform programming.

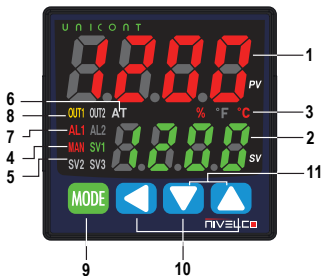

1. Measured Value (PV):

RUN mode: it shows the currently measured value (PV).

Setting mode: it shows the name of the parameter.

2. Set value (SV):

RUN mode: it shows the set value (SV).

Setting mode: it shows the the parameter value.

3. Unit (°C / °F / %) indicator: It displays the unit set in parameter group 3. The unit applies to the displayed values of the PV and SV.

4. Manual control indicator (MAN): it switches on during manual control.

5. Multi SV indicator (SV1, SV2, SV3) LEDs: Indicates the different target value setting currently in use (SV1-3). The base destination field (SV0) is valid if none is active. Not available for all models.

6. Auto-tuning indicator (AT): flashes every 1 second when auto-tuning is executed.

7. Alarm output (AL1) indicator: it turns on when the alarm output is on.

8. Control output (OUT1, OUT2) indicator: it turns on when the corresponding control output is active. During manual control, it switches off if the measured value is 0.0% when using a current output; otherwise, it is switched on continuously. During automatic control, it switches on when the measured value exceeds 3.0% and switches off when it falls below 2.0%.

9. button: It is used when entering parameter group, returning to RUN mode, moving parameter, saving the set value

Functions:



9.1 Press and hold the  button for longer than 2 seconds in RUN mode to enter Setting mode.

9.2 Press and hold the  button for 1.5 seconds to enter another parameter group in Setting mode.

9.3 Press and hold the  button for longer than 3 seconds in to return to RUN mode from Setting mode.

9.4 Press and hold the  button at the last parameter name of any parameter group, and the device returns to the current main parameter group, where other parameter groups can be accessed.

9.5 If no button is pressed within 30 seconds in setting mode, the device will automatically return to RUN mode, and the previously saved setting value will be retained.

10.    buttons: they are used when entering the set value, changing mode, navigating between parameters/values, and changing values up/down.

11. Digital input key: When pressing the   buttons together for 3 seconds, it operates the RUN/STOP, alarm clear, and auto tuning functions.

The characters of the 7-segment display

A	b	c	d	E	F	G	H	I	J	K	L	M
A	B	C	D	E	F	G	H	I	J	K	L	M
n	o	p	q	r	s	t	U	v	w	x	y	z
N	O	P	Q	R	S	T	U	V	W	X	Y	Z
0	1	2	3	4	5	6	7	8	9	0	-1	/
0	1	2	3	4	5	6	7	8	9	0	-1	/
0	1	2	3	4	5	6	7	8	9	0	-1	/

5.2 STARTUP

When energized, the display will flash for one second, at which point all display sections will illuminate. Then the hardware ID code and the input sensor type will flash twice, and the unit will switch to RUN mode. If 'Open' is displayed, there is no source or there is a contact error on the universal input.

In RUN mode, the current temperature or the value provided by the sensor is displayed.

The parameters in each group are related to each other, so please follow the parameter order below.

Parameter group 3 [PAR3] → Parameter group 4 [PAR4] → Parameter group 5 [PAR5] →

Parameter group 2 [PAR2] → Parameter group 1 [PAR1] → SV Setting [SV]

Note: Changing the parameters of parameter group 3 can sometimes restore other related parameters. Always check that such parameters are not affected.

5.3 INPUT SETTINGS [PAR3 → IN-T]

For normal operation, the universal input must first the universal input must be set in 'Setting' mode. Then the input type must be selected according to table 5.3.1 Input types. Default setting: KCaH.

5.3.1 Input Types [PAR3 → IN-T]

The device supports multiple input types, allowing the user to choose from various thermocouples, resistors, and analog voltages/currents.

Input type	Accuracy	Indication	Temperature range (°C)	Temperature range (°F)
K (CA)	1	KCaH	-200...1350	-328...2463
	0.1	KCaL	-199.9...999.9	-199.9...999.9
J (IC)	1	JlCH	-200...800	-328...1472
	0.1	JlCL	-199.9...800.0	-199.9...999.9
E (CR)	1	ECrH	-200...800	-328...1472
	0.1	ECrL	-199.9...800.0	-199.9...999.9
T (CC)	1	TCcH	-200...400	-328...752
	0.1	TCcL	-199.9...400.0	-199.9...752.0
B (PR)	1	B PR	0...1800	32...3272
R (PR)	1	R PR	0...1750	32...3182
S (PR)	1	S PR	0...1750	32...3182
N (NN)	1	N NN	-200...1300	-328...2372

	Input type	Accuracy	Indication	Temperature range (°C)	Temperature range (°F)
Thermocouple (TC)	C (TT)	1	C TT	0...2300	32...4172
	G (TT)	1	G TT	0...2300	32...4172
	L (IC)	1	LicH	-200...900	-328...1652
		0.1	LicL	-199.9...900.0	-199.9...999.9
	U (CC)	1	UCcH	-200...400	-328...752
		0.1	UCcL	-199.9...400.0	-199.9...752.0
	Platinel II	1	PLII	0...1390	32...2534
RTD	Cu 50 Ω	0.1	CU 5	-199.9...200.0	-199.9...392.0
	Cu 100 Ω	0.1	CU10	-199.9...200.0	-199.9...392.0
	JPt 100 Ω	1	JPtH	-200...650	-328...1202
	JPt 100 Ω	0.1	JPtL	-199.9...650.0	-199.9...999.9
	DPt 50 Ω	0.1	DPt5	-199.9...600.0	-199.9...999.9
	DPt 100 Ω	1	DPtH	-200...650	-328...1202
	DPt 100 Ω	0.1	DPtL	-199.9...650.0	-199.9...999.9
	Nickel 120 Ω	1	NI12	-80...200	-112...392
Analog	Voltage	0 ... 10 V	AV1	-1999 ... 9999 (The display point changes according to the decimal point)	
		0 ... 5 V	AV2		
		1 ... 5 V	AV3		
		0 ... 100 mV	AMV1		
	Current	0 ... 20 mA	AMA1		
		4 ... 20 mA	AMA2		

Note: If the input specification is changed, the upper / lower limits of the SV will be automatically set to the maximum/minimum values of the new specification for the temperature sensors. For analog inputs, it sets the analog upper/lower input values to the max/min temperature range and the SV upper/lower limits to the upper/lower scale values. Therefore, the settings need to be reconfigured.

5.3.2 Sensor Temperature Unit

When the input temperature sensor is selected, the [PAR3 - UNIT] can be set to display the desired unit (°C, °F). However, this parameter is not displayed when an analog input is selected. The default unit is °C. When analog input is selected, it is possible to specify the unit [PAR3 - dUNT] (°C, °F, %, OFF). When OFF is selected, the displayed unit is not specified. The LED unit display does not turn on. The default setting is %.

5.3.3 Analog Input Scale Value Settings

By selecting the analog input, the analog input range (upper / lower input limits) and the display scale (upper / lower scale limits) within the selected input range can be set. For analog input, ±5% of the set upper / lower limit is extended. The analog output is also expanded by comparing the input value. (Using a ±5% extension for a temperature sensor input within the temperature range.)

Note: If the upper and lower limit scale settings are the same, ERR will flash twice, and the Setting mode will be displayed.

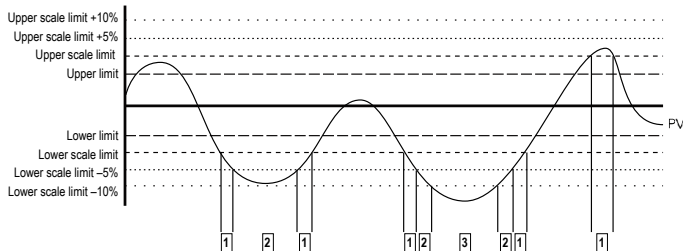

No.	PV	Display
1	$\pm 5\%$ section	PV flashes
2	± 5 to 10% section	HHHH or LLLL flashes
3	Over $\pm 10\%$ section	OPEN flashes

5.3.4 Low-Limit Input Value [PAR3 → L-RG]

The actually used lower limit values can be set within the analog input range. The temperature range from the minimum value to the upper limit [H-RG] - F.S. adjustable up to 10%. Default: 0.

5.3.5 Upper-Limit Input Value [PAR3 → H-RG]

The actually used limit values can be set within the analog input range. The lower input limit [L-RG] + F.S. can be set from 10% to the maximum value of the temperature range. Default: 10.

5.3.6 Scale Decimal Point Position [PAR3 → DOT]

The decimal point position can be set for Current Measured Value (PV) and Set Value (SV) on the upper and lower limit scales. Available settings: 0000 / 000.0 / 00.00 / 0.000. Default: 000.0.

5.3.7 Lower Limit Scale Value [PAR3 → L-SC]

Sets the display scales for the lower limits of the analog input [L-RG]. (Based on the decimal point setting.) Default: 0

5.3.8 Upper Limit Scale Value [PAR3 → H-SC]

Sets the display scales for the upper limits of the analog input [H-RG]. (Based on the decimal point setting.) Default: 100.

5.3.9 Input Offset Correction [PAR3 → IN-B]

This function is used to correct the offset provided by thermocouples, RTDs, or analog input devices. The input correction function is mainly used when the sensor cannot be fixed directly to the controlled objects. Temperature difference compensation must be performed between the sensor installation point and the actual measuring point. Default setting: 0, unit: °C / °F / -.

Example: If the controller shows 78 °C when the actual temperature is 80 °C, set the input correction [IN-B] to "002" to set the temperature displayed on the controller to 80 °C.

Note: If the Process Value (PV) of each input sensor after input correction is out of the input range, "HHHH" or "LLLL" will appear on the display. Make sure that an accurate temperature variance measurement is performed before setting the input correction. Inaccurate initial measurement may result in greater deviation.

5.3.10 Input Digital Filter [PAR3 → MAVF]

Stable control is not possible if the Process Value (PV) fluctuates due to rapid input signal changes. Using the input digital filter function stabilizes the PV for more reliable control. Default setting: 0.1 s.

Example: If the digital input filter is set to 0.4 seconds, the digital filter applies to the sampling value collected in 0.4 seconds. (400 ms).

Note: The Process Value (PV) may differ from the actual input value when using the digital input filter.

5.3.11 Upper Limit [PAR3 → H-SV] and Lower Limit of Set Value (SV) [PAR3 → L-SV]

The Set Value (SV) range can be limited within the temperature range of the temperature sensor or analog input to prevent system control by improper SV.

Parameter	Description / Range	Default
H-SV	SV lower limit +1 digit to upper limit value of sensor input or analog scale	1350 (temperature) °C / °F
		000.0 (analog)
L-SV	Lower limit value of sensor or analog scale to SV upper-limit -1 digit	-200 (temperature) °C / °F
		100.0 (analog)

Note: Setting values outside the min/max input range or analog upper/lower limits is impossible. The previous settings are retained instead of such values. The Setpoint (SV) can only be set within the lower limit of SV [L-SV] and the upper limit of SV [H-SV]. The lower limit of SV [L-SV] must not exceed the upper limit of SV [H-SV].

5.4 OUTPUT SETTINGS

5.4.1 Control output (OUT1/OUT2) selection [PAR3 → OUT1/OUT2]

On models with a current loop output, current (CURR) or SSR drive output can be selected.

Default setting: SSR.

If the OUT1, OUT2 are relay output type, the OUT1, O1SR, O1MA, OUT2, O2SR, and O2MA parameters are unavailable.

5.4.2 SSRP function [PAR3 → O1SR]

SSRP function of SSR drive output is selectable one of standard ON/OFF control, cycle, phase control. By parameter setting, standard SSR drive is available. Also, cycle control connecting with a zero cross turn-on method SSR, phase control connecting with a random turn-on method SSR are available.

Realizing high accuracy and cost effective temperature control with both current output (4-20mA) and linear output(cycle control and phase control).

If the OUT1, OUT2 output is set to current + SSR drive, and the OUT1, OUT2 output setting is SSR, then the O1SR, O2SR output setting is kept in STND, and the parameter is not displayed.

If OUT1 is set to SSRP function SSR drive output and OUT2 output is set to current or SSR drive output, then OUT1, O1MA will not be displayed. Possible settings for O1SR: STND, CYCL, PHAS. If the O2SR parameter is set to SSR, it is held in STND, and the parameter is not displayed.

1. Standard ON/OFF control [STND]

A mode to control the load in the same way as Relay output type.(ON: output level 100%, OFF: output level 0%)

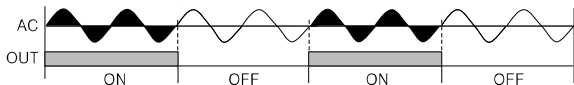

2. Cycle control [CYCL]

A mode to control the load by repeating output ON / OFF according to the rate of output within setting cycle.

Having improved ON / OFF noise feature by Zero Cross type.

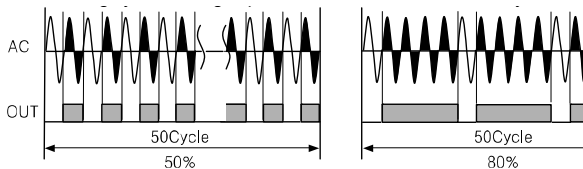

3. Phase control [PHAS]

A mode to control the load by controlling the phase within AC half cycle. Serial control is available. Random turn-on SSR must be used for this mode.

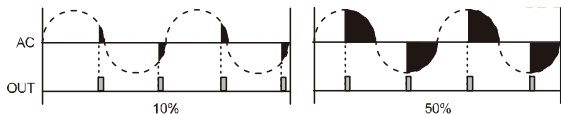

Note: Make sure that SSRP function is not available for OUT2. In case of current type models, SSR is fixed to standard output [STND] only.

When selecting cycle output [CYCL] or phase output [PHAS], the power supply for the load and temperature controllers must be the same.

In case of selecting SSRP function whether cycle output [CYCL] or phase output [PHAS] with PID control type, control cycle is not available to set.

5.4.3 Current output range settings [PAR3 → O1MA/O2MA]

If the control output is set to current output, you can select upper and low-limit range for the current output as either 4...20 mA or 0...20 mA.

O1MA: Sets OUT1's current output range.

O2MA: Sets OUT2's current output range.

Note: This parameter is only available on models supporting current output [OUT1, OUT2].

5.5 CONTROL OUTPUT

Output modes for general temperature control include heating mode or cooling mode and heating and cooling mode. Heating control and cooling control are opposite operations with inverted outputs. The PID time constant varies depending on the characteristics of the section controlled during PID control. **The value of the control output is MV (Manipulated Variable).** MV is a percentage value that controls the switching of the assigned device output according to the settings.

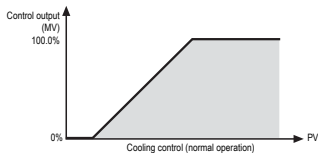
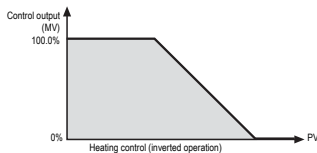

Setting group	Parameter	Range	Default
PAR3	O-FT	Standard model: HEAT / COOL	HEAT
		Heating/cooling model: HEAT / COOL / H-C	H-C

5.5.1 Heating Control [PAR3 → O-FT → HEAT] or Cooling Control [PAR3 → O-FT → COOL]

Heating control mode: If the Process Value (PV) falls below the Set Value (SV), the output will power the heater.

Cooling control Mode: If the Process Value (PV) rises above the Set Value (SV), the output will power the cooler.

5.5.2 Heating & Cooling Control [PAR3 → O-FT → H-C]

Heating and cooling control mode: heating and cooling with a single temperature controller if it is difficult to control the temperature of the object by heating or cooling alone. The heating and cooling control mode uses different PID time constants to control heating and cooling. It is possible to set the heating and cooling control in both PID control and ON / OFF control modes.

For heating and cooling control, the relay control output or SSR1 / Curr1 control output *OUT1* is assigned to the heating control, and the SSR / current control output *OUT2* is assigned to the cooling control. Note that the *OUT2* SSR drive output uses standard (on / off) control.

Note: For the OUT2 SSR/Curr and relay version, the output is controlled in [H-C] mode, the selection menu items are only displayed in this setting. When switching from each control mode [H-C, HEAT, COOL], the settings for the control mode return to the default setting, the set temperature value is retained.

If OUT2 is a relay version, the alarm output 3 (AL3) only works when the [O-FT] output control is set to heating (HEAT) or cooling (COOL) mode, then OUT2 will be used as an alarm output.

If the OUT2 SSR/Curr version and [SSR] is selected, and the control mode is (O-FT) [HEAT] or [COOL], the output is always active.

If the OUT2 SSR/Curr version and [Curr] is selected, and the output control mode is [HEAT] or [COOL], then OUT2 works as a current transmitter and is active all the time.

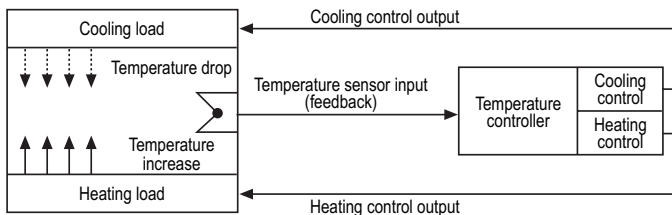

5.5.3 Deadband/Overlap Band [PAR2 → DB]

It is possible to assign a deadband between the heating and cooling control bands based on the Set Value (SV) for heating and cooling. A deadband is formed around the SV when a positive (+) value is set. There is no regulation in the deadband, so the heating and cooling MV (Manipulated Variable) will be 0.0% in the deadband formed. When the negative (-) value is set, an overlap band (simultaneous heating and cooling MVs) is formed around the SV. Set to 0 if no deadband or overlap band is used.

Set to 0 if no deadband or overlap band is used.

When setting the integral time, this applies if the integral time for the heating control and cooling control is set. It also acts as a P-P controller for PI-P control and P-PI control.

Ranges and default settings:

[OUT1 / OUT2]: PID / PID, PID / ON-OFF, and ON-OFF / PID control

- Set the range (temperature): - (proportional band) + (proportional band)
(lower value when using different proportional bands)
- Set the range (analog): -99.9...+99.9
- Default: **0000** (temperature H), **000.0** (temperature L, analog),
(unit: temperature °C / °F, analog % F.S.)

[OUT1 / OUT2]: ON-OFF / ON-OFF control

- Set the range (temperature):
-**999** (overlapping band) -**0000** (not used) -**+999** (deadband) (temperature H)
-**199.9** (overlapping band) -**000.0** (not used) -**+999.9** (deadband) (temperature L)
- Set the range (analog): -**99.9** (overlap band) **000.0** (not used) -**099.9** (deadband)
- Default: **0000** (temperature H), **000.0** (temperature L, analog),
(unit: temperature °C / °F, analog % F.S.)

Using the deadband:

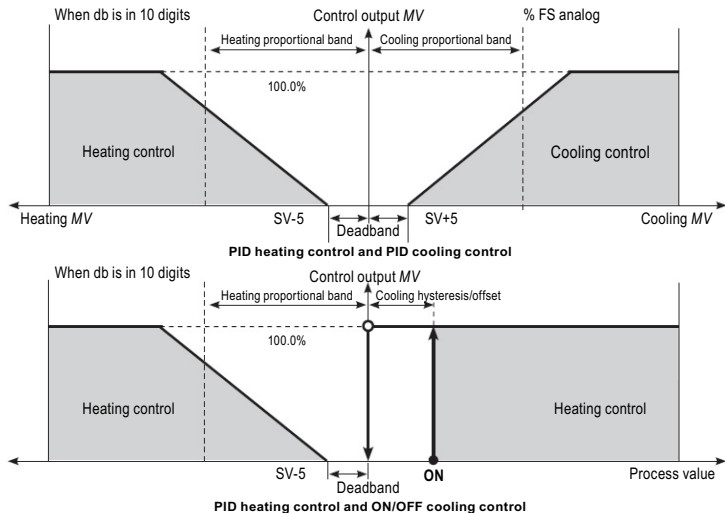

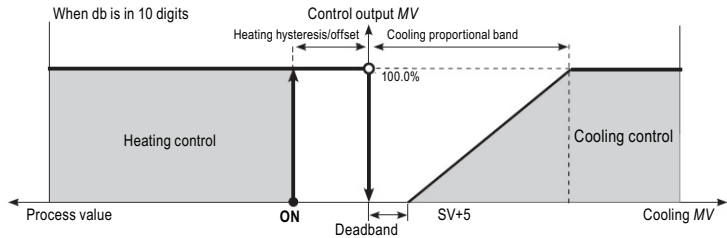

ON/OFF heating control and PID cooling control

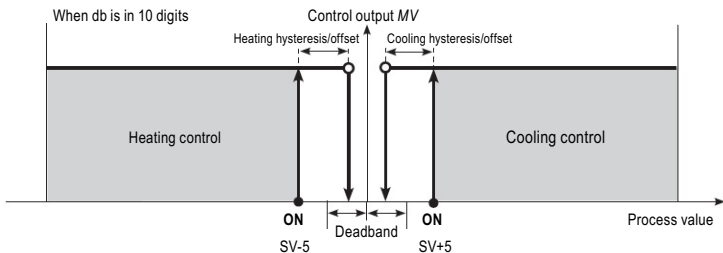

ON/OFF heating control and ON/OFF cooling control

Using Overlap Band

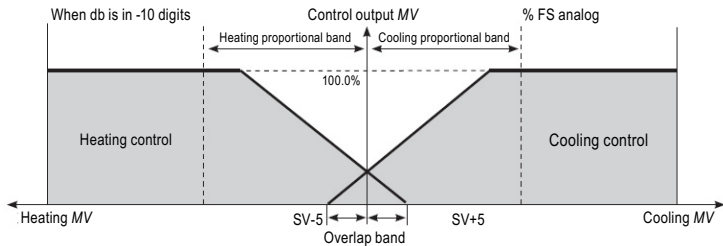

PID heating control and PID cooling control

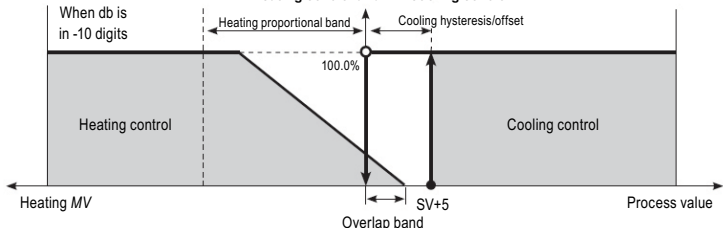

PID heating control and ON/OFF cooling control

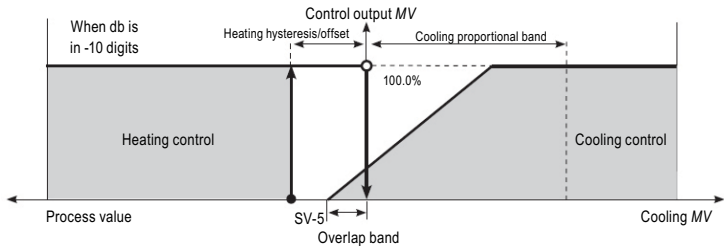

ON/OFF heating control and PID cooling control

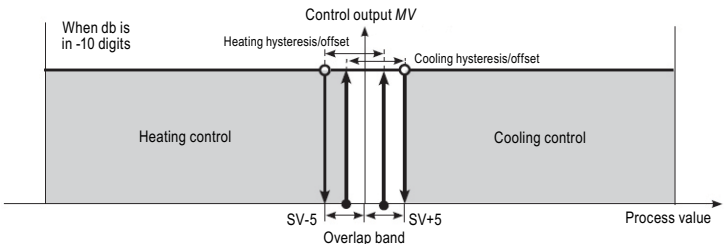

ON/OFF heating control and ON/OFF cooling control

Using neither a deadband nor an overlap band

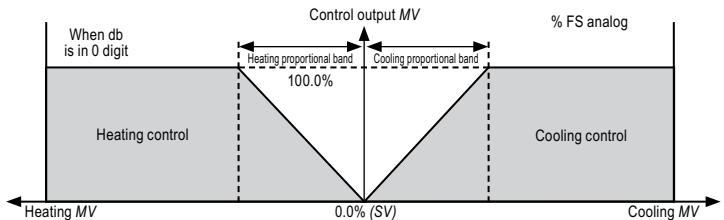

PID heating control and PID cooling control

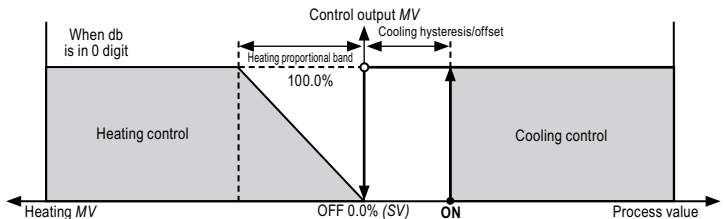

PID heating control and ON/OFF cooling control

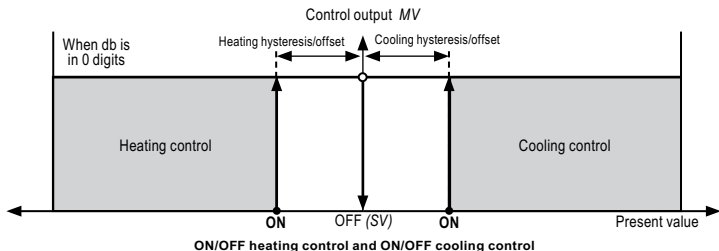
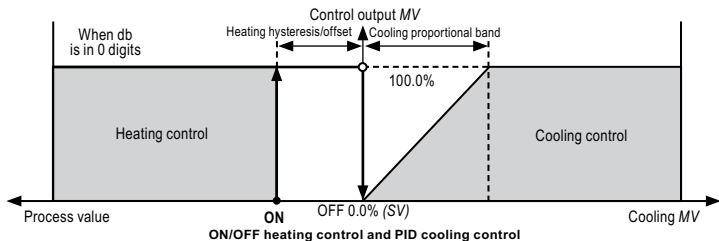

Note: Actual operation may differ depending on the set value of the heating integration time [H-I] and the cooling integration time [C-I].

5.5.4 MV Upper Limit Value [PAR2 → H-MV] and MV Lower Limit Value [PAR2 → L-MV]

The upper / lower limits of the control output MV [H-MV / L-MV] can be set to the actual MV, provided that the MV calculation of the temperature controller exceeds the limits.

When controlling heating and cooling, the cooling MV contains a "-" prefix. Therefore, the upper limit displayed on the heating side is +, and the lower limit is displayed on the cooling side.

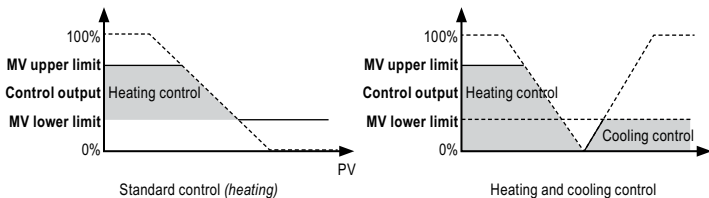

Parameter	Description / Range	Default
H-MV	Standard control: MV lower limit value [L-MV] +0.1...100.0	100.0%
	Heating and cooling control: 000.0...100.0 (PID) 0.0 (OFF)/100.0 (ON) (ON/OFF)	100.0%
L-MV	Standard control: 000.0...MV upper limit value [H-MV] -0.1	0.0%
	Heating and cooling control: -100.0...000.0 (PID), -100.0 (ON) / 0.0 (OFF) (ON/OFF)	-100.0%

Note: The same MV limits apply during auto-tuning. The MV limits do not apply to manual control, MV when control is stopped, MV sensor failure, and initial manual control. The MV upper / lower limit configuration is not available in the ON / OFF standard control mode (heating or cooling control).

5.5.5 MV Settings for Sensor Break Error [OPEN] [PAR5 → ErMV]

In the event of an open sensor error, the output value of the controller can be set to a predefined MV value instead of ON / OFF or PID control. Ignores the MV based on the ON / OFF or PID control and sends a control value based on the specified MV. Default setting: 0.0%

5.5.6 RAMP Settings [PAR2 → RAMU/ RAMD/ rUNT]

The ramp is a function that configures the temperature per unit time to the Setpoint (SV). The function limits the rate of change of the Set Value (SV) and thus limits sudden temperature changes (*increase and decrease*) in the control system.

The ramp is typically used in applications where rapid temperature changes (*increase and decrease*) can adversely affect the controlled system.

Control is based on the changed SV (*hereafter: RAMP SV*) – based on the preset rate of change (*temperature changing per unit time*). The RAMP uplink rate and the RAMP downlink rate can be configured independently.

Parameter	Description / Range	Default
RAMU	Setting for RAMP-UP change rate	0 °C / °F / Digit
RAMD	Setting for RAMP-DOWN change rate	
rUNT	RAMP time unit (SEC / MIN / HOUR)	MIN

Note: Activating the RAMP function when RAMP is not operating limits the Set Value (SV) rate of change based on the Process Value (PV). Changing the SV or RAMP parameters during RAMP operation limits the rate of change of SV based on SV at the time of change.

The alarm occurs during the RAMP based on the final SV. Setting the RAMP rate to 0 turns off the RAMP function. When the RAMP function is on, RAMP SV appears in the SV display area.

RAMP depending on operating status:

Operation	Ramp UP/DOWN	Ramp
All operations	When 0	Inactive
OPEN, HHHH, LLLL, auto-tuning, switching from Auto to Manual, switching from Run to Stop	Regardless of status	Inactive
OPEN, HHHH, LLLL, after Auto-tuning has finished, PV = SV	Regardless of status	Inactive
Switching ON, SV change, switching from Stop to Run, switching from Manual to Auto, Ramp rate change	When not 0	Active

Ramp operation diagram

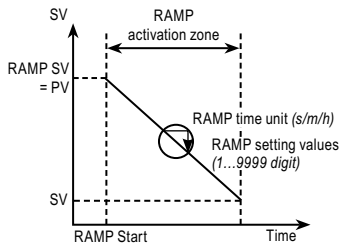
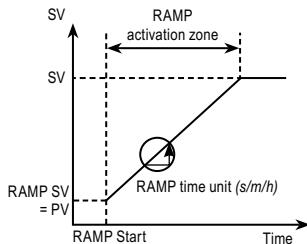

Activating RAMP, when RAMP is off

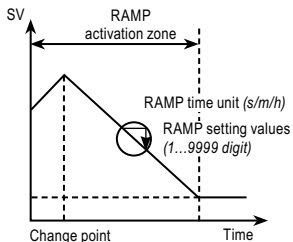
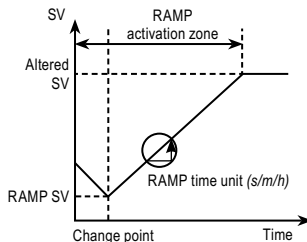

Changing SV or RAMP parameter when RAMP is on

5.5.7 Auto/Manual control settings

The automatic mode is for the temperature to reach SV with the MV value calculated by the PID control. The purpose of the manual mode is for the temperature to reach SV with a user-defined MV value.



*Note: In manual mode, parameter settings can only be viewed and cannot be changed (except for lock parameters). If the [DI-1] digital input terminal function is set to automatic / manual [MAN], the **MODE** button and automatic/manual changeover will not work with communication. If the unit is turned on after a power failure or shutdown, the previous mode (automatic or manual) will be retained.*







It is possible to switch to manual mode during STOP state. It is also possible to switch between automatic / manual mode during adjustment, but automatic tuning will stop if manual control is switched on during automatic tuning. If a sensor break alarm occurs in [SBA] normal mode, the MV [ErMV] sensor fault will occur. The MV settings for manual and automatic control can be changed in this state.

Operational priority: Manual control > Stop > Open (sensor disconnected)





















5.5.7.1 Switching Between Manual/Auto Control



Switching to manual mode for standard control (heating or cooling):

- In 'Normal' mode, press the **MODE** button, and the device will switch to MV monitoring mode. The SV display shows **H** (heating control) or **C** (cooling control) and shows MV, indicating the start of MV monitoring.
- If any of    is pressed during MV monitoring, the **MAN** indicator will turn on, and the lowest digit (100 digits) will flash to indicate that the manual control is active.

- Press the  button to move the flashing digit ($10^0 \rightarrow 10^1 \rightarrow 10^2 \rightarrow 10^3 \rightarrow 10^0$).
- Select the digit and configure the desired *MV* value with the    buttons $0 \rightarrow 1 \rightarrow 2 \rightarrow 3 \rightarrow 4 \rightarrow 5 \rightarrow 6 \rightarrow 7 \rightarrow 8 \rightarrow 9 \rightarrow 0$ using the   buttons.
- In either state, press the  button to end manual control. The *MAN* indicator light goes out, and the system returns to automatic control mode.

Switching to manual mode for heating and cooling control:

- In "Normal" mode, press the  button, and the heating *MV* supervision mode is activated. The *SV* display shows "H" and the *MV* indicates the start of the heating *MV* monitoring.
- If one of the    buttons is pressed while the heating *MV* is being monitored, the *MAN* indicator light comes on, and the lowest digit (*100 digits*) flashes to indicate that the manual control has been activated.
- Press the  button to move the flashing digit ($10^0 \rightarrow 10^1 \rightarrow 10^2 \rightarrow 10^3 \rightarrow 10^0$).
- Select the digit and set the desired *MV* value with the    buttons and switch between $0 \rightarrow 1 \rightarrow 2 \rightarrow 3 \rightarrow 4 \rightarrow 5 \rightarrow 6 \rightarrow 7 \rightarrow 8 \rightarrow 9 \rightarrow 0$ using the   buttons.
- Press the  button again, and the cooling *MV* monitoring mode is activated. 'C' appears on the *SV* display and *MV* indicates the start of cooling *MV* monitoring.
- The lowest digit (*100 digits*) will flash if any of the    buttons are pressed during cooling *MV* monitoring.
- Press the  button to move the flashing digit ($10^0 \rightarrow 10^1 \rightarrow 10^2 \rightarrow 10^3 \rightarrow 10^0$).
- Select the digit and set the desired *MV* value by using the    buttons, and use the   buttons to switch between $0 \rightarrow 1 \rightarrow 2 \rightarrow 3 \rightarrow 4 \rightarrow 5 \rightarrow 6 \rightarrow 7 \rightarrow 8 \rightarrow 9 \rightarrow 0$.
- In any condition, press the  button to end the manual control mode. The *MAN* indicator light goes out, and the system returns to automatic control mode.

*Note: After heating and cooling control, the system returns to automatic control in the order of heating monitoring, manual heating control, cooling monitoring, and manual cooling control. To switch between automatic and manual mode, press the  button once. The heating *MV* remains valid during cooling monitoring and manual cooling control. When the [DI-1] digital input function is set to AUTO / MANUAL [MAN], the  button on the front panel and the auto / manual control functions via communication do not work.*

Switching Manual / Auto control using the digital input (DI) connector:

If the digital input function [DI-1] AUTO / MANUAL control switch is set to [MAN], turn on the DI to activate manual mode (*the MAN indicator lights up*) and turn off the DI to activate automatic mode. If the digital input function is automatic, it can only be monitored. If it is manual, it is possible to change the *MV* and monitor it.

Note: See 5.10.6 Digital Input for detailed information about the digital input (DI) terminal settings.

5.5.7.2 Initial *MV* for Manual Control [PAR5 \rightarrow ItMV]

The initial *MV* value can be set when the device is switched from automatic [AUTO] to manual control [PrMV]. Default setting: AUTO.

- **AUTO:** automatically adjusted *MV*, as initial *MV* for manual control.
- **PrMV:** manually set initial *MV* [PrMV].

*Note: When the power is turned back on, it starts with *MV* that was in use when the power was turned off.*

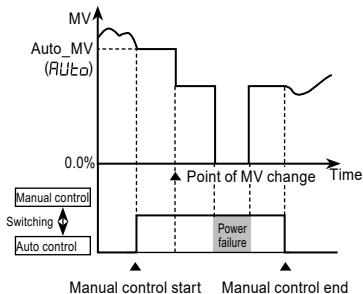

Auto-MV [AUTO]

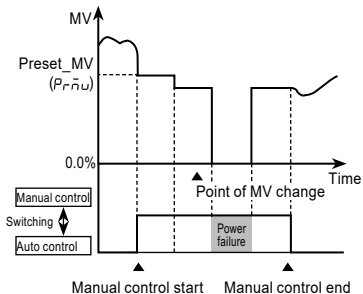

Preset MV [PrMV]

5.5.7.3 Initial MV Manual Control [PAR5 → PrMV]

If the basic MV for manual control is set to PrMV, the initial MV can be set to manual mode. For ON / OFF and PID control, the default setting is Standard or Heating and Cooling: 0.0%.

Note: In heating and cooling control mode, a value between 0.1 and 100.0 is used as the heating MV, and a value between 0.1 and -100.0 is used as the cooling MV.

5.6 TEMPERATURE CONTROL

5.6.1 Temperature Control Mode

[PAR3 → C-MD]

Choose the type of temperature control method.

Default setting: PID/PP

Setting		Description	
		Heating	Cooling
Standard Control	PID	PID	
	ONOF	ON/OFF	
Heating & Cooling Control	PP	PID	PID
	PON	PID	ON/OFF
	ONP	ON/OFF	PID
	ONON	ON/OFF	ON/OFF

5.6.2 ON/OFF Control with Hysteresis Function [PAR3 → C-MD → ONOF]

It controls the temperature by comparing the process value (PV) with the set value (SV) and switching the load on or off.

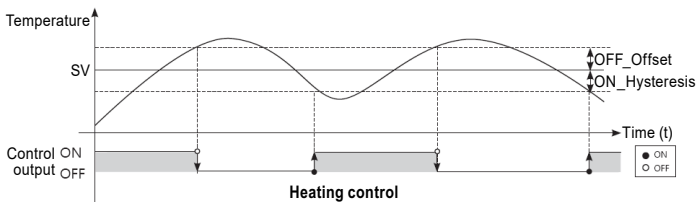

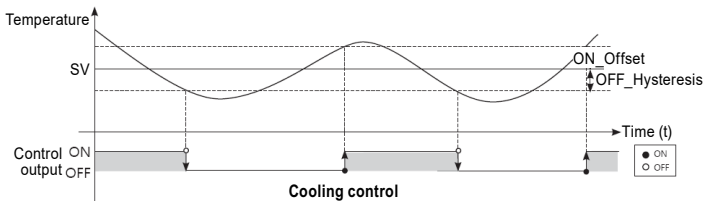

Hysteresis [PAR2 → hHYS/hOFT/cHYS/cOFT]

Hysteresis is the setting of the control output on and off point in ON / OFF mode. *ON_Hysteresis* sets the output to an ON point, and *OFF_Offset* sets an off point. The values are set in °C / °F.

If the hysteresis is set too low, the disturbing characteristics that affect the device (*noise, etc.*) will turn the output control (*compared to the control characteristics*) uncertainly on and off, which should be avoided. To minimize this condition, adjust the *ON_Hysteresis* and *OFF_Offset* values according to the control characteristics (*e.g., heater or cooling capacity and temperature*) and the operator response, sensor response characteristics, and installation conditions.

Parameter	Description / Range	Default
hHYS	Sets <i>ON_Hysteresis</i> to heating control	002
hOFT	Sets <i>OFF_Offset</i> to heating control	
cHYS	Sets <i>ON_Hysteresis</i> to cooling control	000
cOFT	Sets <i>OFF_Offset</i> to cooling control	

5.6.3 PID Control [PAR3 → C-MD → PID]

PID control is a combination of the proportional (*P*), integral (*I*), and differential (*D*) control and provides excellent control over the devices, even with a delay time. The device uses the same *PID* time constant for SV0... SV1.

Proportional control (*P*) follows the set control value well with a small error; integral control (*I*) automatically corrects the error, and differential control (*D*) accelerates the response to the control. Through these operations, *PID* control achieves ideal temperature control.

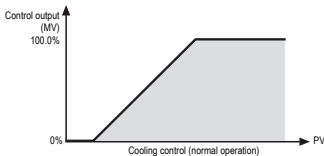
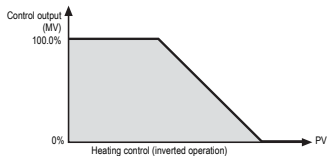

Note: The *PID* controller can also be set as a *P*, *PI*, or *PD* controller.

Proportional control (*P*): Select *PID* control and set the integration and differential time to 0000.

Proportional Integral Control (*PI*): Select *PID* control and set the differential time to 0000.

Proportional Differential Control (*PD*): Select *PID* control and set the integration time to 0000.

5.6.3.1 Setting the Proportional Band for Heating [PAR2 → H-P] and Cooling [PAR2 → C-P]

If the Process Value (PV) is within the proportional band (P), the ON / OFF ratio must be adjusted during the proportional period (T). The defined proportional control (*time proportional control*) section is called the proportional band. Default value: 10.0. It is set in °C / °F / %.

5.6.3.2 Setting Integral Time for Heating [PAR2 → H-I] and Cooling [PAR2 → C-I]

MVs from integrative and proportional operation become identical if the deviation is consistent. The time required for the two MVs to match is called the integral time. Default value: 0 s.

Note: Integration does not occur if the integral time is set to 0. Setting the integral time too short can increase correction movements and cause control oscillations.

5.6.3.3 Setting Derivative Time for Heating [PAR2 → H-D] and Cooling [PAR2 → C-D]

According to the difference of the ramp, the MV obtained from the derivative operation and the time required to reach the MV obtained from the proportional control are called the derivative time.

Note: The differentiation member stops when the derivative time is set to 0.

5.6.3.4 Setting Control Period for Heating [PAR3 → H-T] and Cooling [PAR3 → C-T]

If a relay or SSR is used with control proportional to the MV output, the output will be on for a period of time (*within the control period, as a percentage of the MV*) and will remain off for the rest of the time. The preset period when the output is ON / OFF is called the proportional control period.

Control with SSR drive output is faster than relay output. Therefore, setting a shorter control period can achieve more sensitive temperature control.

Default – Relay: 20.0 s / SSR: 2.0 s.

Note: If heating and cooling control is used, configure the control period for heating and cooling separately.

5.6.3.5 Offset Correction / Manual Reset Settings [PAR2 → REST]

When selecting the P / PD control mode, there are some temperature differences even after the PV is stable because the temperature rise and fall times of the heater are inconsistent with the thermal characteristics of the controlled section, such as heat capacity and heater capacity. This temperature difference is called *OFFSET*. The offset can be corrected by manual reset.

Default: 50%

Manual reset settings based on control results:

Under stable control conditions, set the offset to 50% if PV and SV are the same, above 50.0% if PV is lower than SV, and below 50.0% if PV is higher than SV.

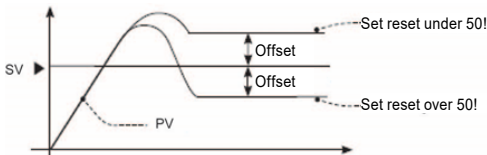

Note: offset correction can only be used if proportional control (P) is on. If the integral value is set to 0, the manual reset parameter is displayed. The user cannot configure the manual reset setting during heating and cooling control. Instead, the setting is automatically set to 0% for heating and cooling. Only applicable if the integration time is set to 0 during P or PD control. Switching from heating and cooling control to normal control (P, PD control) automatically sets the reset settings to 50%

5.6.4 Auto-Tuning

Automatic tuning measures the controlled section's temperature characteristics and thermal response rate and then determines the required PID time constants. (If the [C-MD] control type is PID, it is displayed.)

This operation will stop automatically if an [OPEN] error occurs during auto-tuning.

To stop auto-tuning, change the setting to OFF. (In this case, the P, I, D values before auto-tuning are retained.)

5.6.4.1 Auto-Tuning ON/OFF [PAR2 → AT]

Auto Tuning automatically stores the PID time constants when completed. These PID time constants can then be modified according to their usage environment. Default setting: OFF.

When auto-tuning is in progress, the AT indicator on the controller's front flashes every 1 second. When auto-tuning is completed, the AT indicator will automatically turn off, and the auto-tuning parameter will return to the OFF position.

Note: When auto tuning is in progress, and the [DI-K] digital input button function is set to RUN / STOP [STOP] or auto-tuning RUN / STOP [AT] and the digital input terminal [DI-1] function switches RUN / STOP [STOP] or AUTO / MANUAL control selection [MAN], auto-tuning stops automatically when the affected DI is entered, or a sensor disconnection error occurs. (Resets the PID used before auto-tuning).

Setting	Description
OFF	Auto-tuning is off or finished
ON	Auto-tuning is in progress

Note: Auto-tuning will continue even if the temperature value exceeds or falls within the input range. When auto-tuning is in progress, the parameters can only be referenced but not modified. Auto-tuning is not available for manual control.

5.6.5 Auto-Tuning Mode Settings [PAR3 → AtT]

Auto tuning is available in [TUN1] mode (based on SV) or [TUN2] mode (based on 70% of SV), depending on the default value used. Default setting: TUN1.

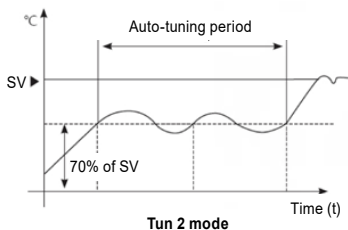
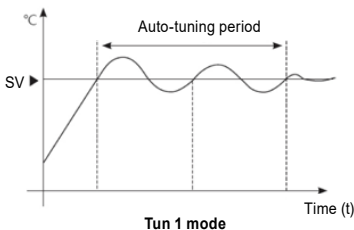

Setting	Description
TUN1	Automatically tunes and derives the PID time constant based on the Set Value (SV).
TUN2	Automatically tunes and derives the PID time constant based on 70% of the Set Value (SV).

Note: In cooling control mode, [TUN2] mode calculates 70% based on 0. If SV = -100, it occurs at [TUN2] -70.

5.7 ALARM OUTPUT

There are three alarms that operate separately. In addition, the combined alarm operation and alarm option can be set. Use the digital input setting as **[AIRE]** or turn off the unit and restart the unit to clear the alarm operation.

Note: The three alarm outputs are accessed differently on each device. The AL1 alarm output is built into all devices, but the other alarm outputs depend on the type.

5.7.1 Alarm Operation [PAR4 → AL-1]

Select the alarm operation. Default setting is "DV[[["

Mode	Name	Alarm operation	Description (default)
OFF	-	-	No alarm output
DV]]	Deviation upper limit alarm	<p>Upper deviation: Set to 10 °C</p> <p>Upper deviation: Set to -10 °C</p>	If the deviation between PV and SV is higher than the set value for the high temperature deviation, the alarm output will turn on. The upper limit deviation temperature can be set at AL1H .
]]DV	Deviation lower limit alarm	<p>Lower deviation: Set to 10 °C</p> <p>Lower deviation: Set to -10 °C</p>	If the deviation between PV and SV is higher than the deviation temperature setpoint as a lower limit, the alarm output will turn on. The lower limit can be set for the AL1L .
]]DV[Deviation upper / lower limit alarm	<p>Lower deviation: Set to 10 °C Upper deviation: Set to 20 °C</p>	If the deviation of the upper / lower limit between PV and SV is higher than the deviation temperature setpoint, the alarm output will turn on. The upper limit deviation temperature can be set in AL1H . The lower limit deviation temperature can be set in AL1L .

[DV]	Reverse alarm upper / lower limit		If the difference between the PV and SV upper / lower limit is higher than the set temperature difference, the alarm output will turn off. The upper limit deviation can be set in AL1H . The lower limit deviation can be set in the AL1L .
PV[[Absolute value upper limit alarm		If the PV is higher than the absolute value, the output will turn on. The absolute value alarm can be set in AL1H .
]]PV	Absolute value lower limit alarm		If the PV is lower than the absolute value, the output will turn on. The absolute value of the alarm can be set in the AL1L .
LBA	Loop break alarm	-	Turns on when it detects a loop break.
SBA	Sensor error alarm	-	It turns on when the connection to the sensor is lost.
HBA	Heating error alarm	-	It turns on when the CT detects a break in the heater.

5.7.2 Alarm Output Settings [PAR4 → AL1T]

Users can select alarm output settings. Default setting: AL-A

Setting	Mode	Description
AL-A	Standard alarm	If there is an alarm condition, the alarm output is ON. If there is no alarm condition, the alarm output is OFF.
AL-B	Alarm latch	If an alarm condition exists, the alarm output is ON and remains ON.
AL-C	Standby sequence 1	The first alarm condition is ignored, and the second alarm condition operates in normal alarm mode. If there is power supplied and there is an alarm condition, the first alarm condition is ignored and the standard alarm operates from the second alarm condition.
AL-D	Alarm latch and standby sequence 1	If there is an alarm condition, it activates the alarm latch and the standby sequence. If there is power and there is an alarm condition, the first alarm condition is ignored and the alarm latch operates from the second alarm condition.

AL-E	Standby sequence 2	The first alarm condition is ignored, and the second alarm condition is the normal alarm. When the standby sequence is re-applied and an alarm condition occurs, the alarm output will not turn on. After clearing the alarm condition, the standard alarm will operate.
AL-F	Alarm latch and standby sequence 2	The basic operation is the same as the alarm latch and the 1st standby sequence. Not only does it work by turning on / off, but also changing the alarm setting value or alarm option. Re-application of the standby sequence and if there is an alarm condition, the alarm output will not turn on. After clearing the alarm condition, the alarm latch will operate.

- Condition for re-use of Standby Sequence 1, Alarm Latch, and Standby Sequence Series 1: Power ON
- Condition of standby sequence 2, alarm latch and repeated standby mode of standby sequence 2 again: switch on, change set temperature, alarm temperature **[AL1]** or alarm operation **[AL-1]**, switch STOP mode to "Normal" mode.

Note: If the alarm operation is set to loop break alarm [LBA], sensor fault alarm [SBA] or heating fault alarm [HBA], only the standard alarm [AL-A] and alarm interlock [AL-C] will be displayed.

5.7.3 Alarm Output Lower **[PAR1 → AL1L]** and Upper **[PAR1 → AL1H]** Limit Value Settings

Output alarm activation values can be set. The **[AL1H / AL1L]** configuration parameters are activated for each setting according to the selected alarm operation. The upper / lower limit values are according to the individual input specification of the sensor. The lower limit is the reference value for determining burnout of the heating element.

Default setting - Temperature: 1550 / Analog: 100.0

Note: Changing the alarm action or options will reset the settings to the highest or lowest values that will not trigger output in the new mode.

5.7.4 Alarm Output Hysteresis **[PAR4 → A1HY]**

Setting the on / off interval for alarm output 1 (5.7.1 Alarm operation **[PAR4 → AL-1]**). "H" means the hysteresis of the alarm output in alarm operation. It is used to set the interval between the ON / OFF periods of the alarm outputs.

Default setting: 1. It is set to °C / °F / %.

Note: Alarm Output Hysteresis applies the same to Heating error alarm [HBA]. This parameter is not displayed when Loop Break Alarm [LBA] or Sensor Fault Alarm [SBA] is selected.

5.7.5 Alarm NO/NC [PAR4 → A1N]

Selects the contact type for alarm output 1. The contact mode of the relay can be set in the event of an alarm. Default setting: NO.

Setting	Description
NO	Normally open – Stays open normally and closes when there is an alarm.
NC	Normally closed – Stays closed normally, opens only when there is an alarm.

Front LED Indicators

Change	Alarm trigger	Alarm output	Front LED
NO (normally open)	OFF	Open	<input type="checkbox"/> OFF
	ON	Close	<input checked="" type="checkbox"/> ON
NC (normally closed)	OFF	Close	<input type="checkbox"/> OFF
	ON	Open	<input checked="" type="checkbox"/> ON

5.7.6 Alarm Output Delay Settings [PAR4 → A10N / A10F]

The alarm output delay can be set to prevent false alarms caused by faulty input signals due to interference or noise. The default setting for both parameters: 0 s.

If there is a preset delay time, the alarm output will not turn on for the preset time. Instead, the front alarm indicator flashes every 0.5 seconds.

Parameter	Description
A10N	Alarm Output 1 on Delay: In the event of an alarm event, it is on standby for a preset period of time, checks the conditions for activating the alarm, and turns on the alarm output if the conditions persist.
A10F	Alarm Output 1 Off Delay: After the alarm output is turned off, it is ready for a preset period, checks the alarm trigger conditions, and turns off the alarm output if the deactivation conditions continue.

5.7.7 Loop Break Alarm (LBA) [PAR4 → AL-1/ → LBA]

Diagnose the control loop by monitoring the temperature change in the control circuit and send alarms if necessary.

- Heating control: If the *MV* control output is 100% or the upper limit [**H-MV**] and the *PV* does not exceed the LBA detection band [**LBaB**] during the LBA monitoring time [**LBaT**], or if the control output *MV* is 0% or lower limit [**L-MV**] and *PV* do not fall below the LBA detection band [**LBaB**] during the LBA monitoring time [**LBaT**], the alarm output will turn on.
- Cooling control: If the *MV* control output is 0% or lower limit [**L-MV**] and the *PV* does not increase at the LBA detection band [**LBaB**] during the LBA monitoring time [**LBaT**], or if the control output *MV* is 100% or upper limit [**H-MV**] and *PV* do not fall below the LBA detection band [**LBaB**] during the LBA monitoring time [**LBaT**], the alarm output will turn on.

Common reasons triggering the LBA output:

- Sensor fault (*disconnection, short circuit*)
- External control fault (*magnet, auxiliary relay, etc.*)
- External load fault (*heating, cooling, etc.*)
- Incorrect connection and disconnection of the external network.

During auto-tuning / manual control / STOP / Ramp function, the loop break alarm does not work except for the sensor fault indication (**HHHH** / **LLLL**).

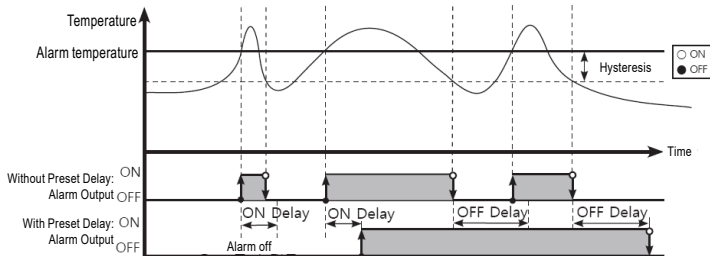

Type	LBA Monitoring period	Alarm output	
		Standard alarm	Alarm latch
Initializing Alarm, changing control output operation mode, setting LBA monitoring time/band as 0	Initializing	OFF	
Changing input correction value, set value		Maintains the present alarm	
Changing MV, stopping control, running auto-tuning	Initializing	OFF	Maintains the present alarm
Occurring sensor break alarm, HHHH, LLLL		ON	ON

When performing auto-tuning, the LBA detection band [LBaB] and LBA monitoring time [LBaT] are automatically set based on the auto-tuning value.

For AT (auto-tuning) / manual control / stop control, the loop break alarm [LBA] does not work.

5.7.8 LBA Monitoring Period [PAR4 → LBaT]

The LBA monitoring time can be set to control the temperature changes of the controlled section. Automatic adjustment with automatic tuning. Default setting: 0 s.

- Regardless of the operation of the alarm [AL- □] (including when the LBA supervision time is 0), the integration time × 2 value is automatically saved after running auto-tuning.
- (If the SV is outside the auto-adjustment range, the auto-adjustment will be set to the maximum or minimum.)
- Except for changing the input type, restarting auto tuning, and setting the LBA monitoring time manually, it maintains the current SV.
- Automatic setting range: 0020... 9999

5.7.9 LBA Detection Band [PAR4 → LBaB]

The minimum deviation value can be set to decrease during the LBA monitoring time. Automatic adjustment with automatic tuning. (If the SV is outside the auto adjustment range, the auto adjustment will be set to the maximum or minimum value.)

- Except changing the input type, restarting auto tuning, setting the LBA monitoring time manually, it maintains the current SV.
- Regardless of the operation of the alarm (including the LBA monitoring time as "0"), the integration time × 2 value is automatically saved after running auto tuning.

Parameter	Description	Automatic setting range	Default
LBaB	Temperature H (upper)	002.0...100.0 °C / °F	002 °C / °F
	Temperature L (lower)	0002...010.0 °C / °F	002.0 °C / °F
	Analog	000.2...010.0% F.S.	000.2% F.S.

Example: Checks the control loop and issues an alarm when the temperature of the object changes. For heating control (cooling control), if the MV control output is 100% (0% for cooling control) and the PV does not rise beyond the LBA detection band [LBaB] during the LBA monitoring time [LBaT], or if the control output is MV 0% (For 100% cooling control) and the PV does not fall below the LBA detection band [LBaB] during the LBA monitoring time [LBaT], the alarm output is ON.

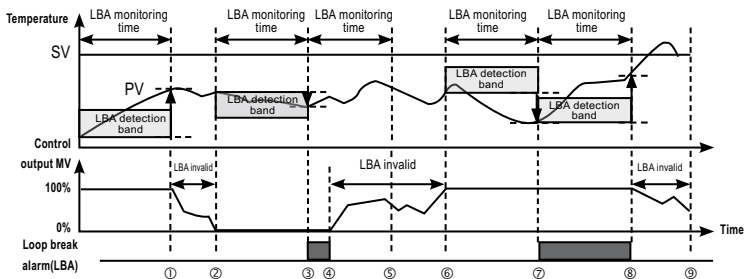

Start ...①	If the MV control output is 100%, the PV exceeds the LBA detection band [LBaB] during the LBA monitoring time [LBaT].
①...②	MV control output change status (LBA supervision time resets)
②...③	If the MV control output is 0% and the PV does not fall below the LBA detection band [LBaB] during the LBA monitoring time [LBaT], the loop break alarm (LBA) will turn on after the LBA monitoring time [LBaT].
③...④	The control output MV is 0% and the loop break alarm (LBA) turns and remains on.
④...⑥	MV control output change status (LBA supervision time resets)
⑥...⑦	If the MV control output is 100% and the PV does not rise above the LBA detection band [LBaB] during the LBA monitoring time [LBaT], the loop break alarm (LBA) will turn on after the LBA monitoring time [LBaT].
⑦...⑧	If the MV control output is 100% and the PV exceeds the LBA detection band [LBaB] during the LBA monitoring time [LBaT], the loop break alarm (LBA) will turn off after the LBA monitoring time [LBaT].
⑧...⑨	MV control output change status (LBA supervision time resets).

5.7.10 Sensor Break Alarm [PAR4 → AL-1 → SBA]

The controller can be set to send an alarm if no sensor is connected or it is disconnected during temperature control.

The sensor fault can be confirmed via an external alarm output contact, such as an audible signal or the like.

If the alarm operation is set to [AL-1] SBA, the sensor fault alarm will be activated.

Note: The alarm output option can be set to standard alarm [AL-A] or alarm latch [AL-B].

5.7.11 Heater Burnout Alarm [PAR4 → AL-1 → HBA]

If a heater is used to increase the temperature of the controlled section, the PMG-500 temperature controller can be set to monitor the heater power supply and send an alarm if it detects a heater connection fault.

The device detects the power supply to the heater using a current transformer (CT) which converts the current to the heater to a specified ratio (CT ratio) for inspection. If the heating current [CT-A] measured by the CT is less than the setting value of the heating sensor [AL1L], the heater burnout alarm is activated.

Note: Heating element burnout is only detected when the temperature controller output is on. Otherwise, the controller will not detect the heater burnout. The heater burnout alarm function varies by model and control output type. The heating-and-cooling model can use the heating burnout alarm function in OUT1. Current detection does not occur if the control output time of OUT1 is less than 250 ms. The alarm output option can be set to standard alarm [AL-A] or alarm lock [AL-B].

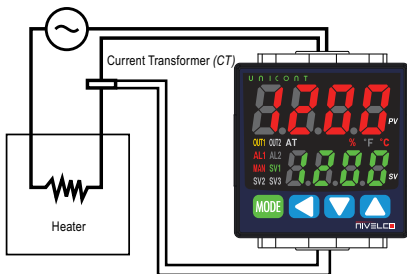

Heater burnout detection settings [PAR1 → AL1L]

Set the alarm output value [AL1L] as the reference value to detect the heater burnout. Default setting: 0.0. Unit: A.

Note: Set to 0.0 to turn off. Set to 50.0 to turn on.

Calculation of setting value

$$\text{Heating burnout set value} = \{(\text{normal heating current}) + (\text{heating burnout current})\} / 2$$

Example: If two output heaters (200 V AC, 1 kW, 5 A) are used, the normal heating current is 10 A (5 A × 2). If one of the heaters burns out, the heating current will be 5 A. The set value (10 A + 5 A) / 2 = 7.5 A. Heating current values below 7.5 A are considered to be a heating element burner and the alarm will turn on.

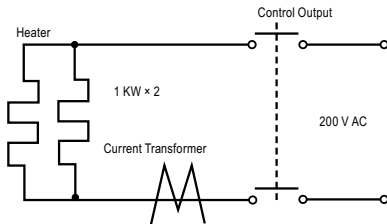



5.7.12 Alarm Output Deactivation [PAR5 → DI-K → ALRE]

Available only when the alarm output is set to alarm latch or alarm latch and standby sequence 1, alarm latch and standby sequence 2. It can be set to turn off the alarm output when the alarm output is on, the alarm output conditions are cleared, or the alarm output deactivation signal is greater than the minimum signal band. (However, deactivating the alarm output is not available if the alarm conditions are still valid.)

The front panel digital input button function [DI-K] or the digital input terminals [DI-1] can be assigned to the alarm output deactivation function [AIRE].

To deactivate the alarm output with the digital input button

If the [DI-K] digital input button is assigned to turn off the alarm output [AIRE] and the alarm output option is set to alarm latch or alarm latch and standby sequence, press and hold   buttons on the front panel when the alarm output is on.

To turn off the alarm output using a digital input (DI) terminal

If the digital input (DI) terminal [DI-1] is assigned to deactivate the alarm output [AIRE], the alarm output will turn off when the digital input (DI) terminal is on (closed) (the MAN indicator light comes on).

Note: For detailed information on the digital input (DI) button configuration, see "5.10.6.2 Digital Input Button". For detailed information on digital input (DI) terminal configuration, see "5.10.6.1 Digital input terminal settings [PAR5 → DI-1]". After deactivating the alarm output, it will operate normally at the next alarm output.

5.7.13 Alarm Output Examples

Absolute upper limit alarm and deviation upper limit alarm

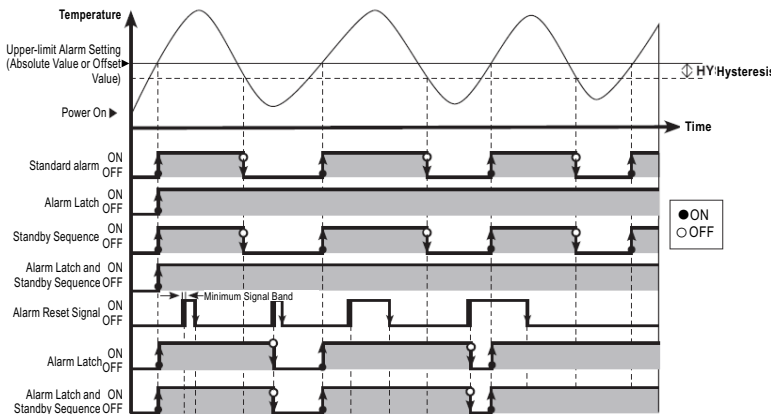

Deviation upper / lower limit alarm

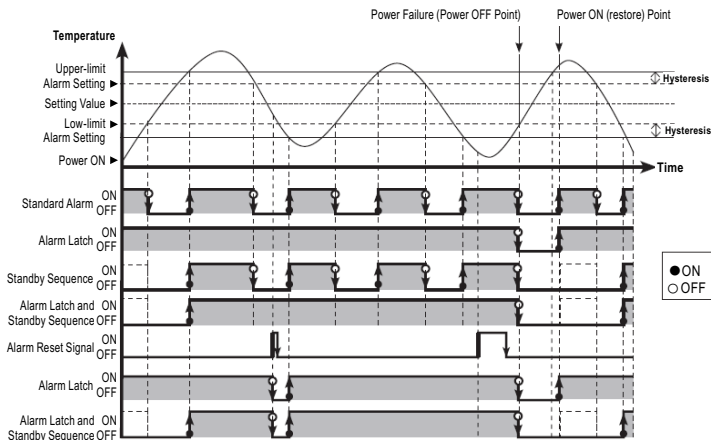

Deviation upper / lower limit alarm (hysteresis overlap)

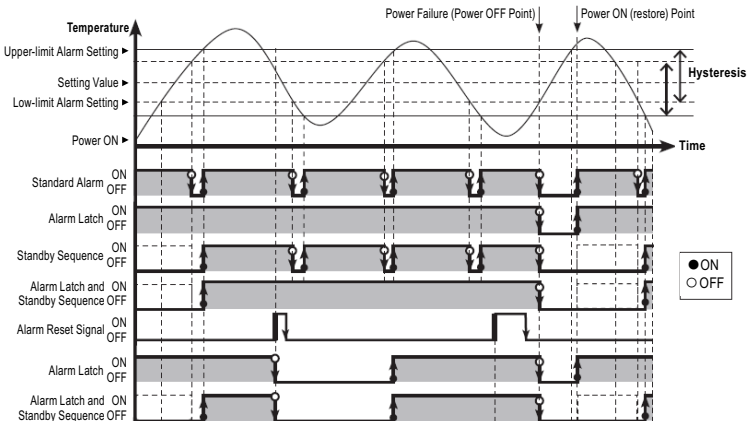

5.8 ANALOG TRANSMISSION

5.8.1 Analog Transmission Output Value Settings [PAR4 → AoM1]

The analog transmission output is an auxiliary output that converts the controller present value, set value, heating *MV*, cooling *MV* to analog current (*DC 4... 20 mA*) for external transmission. Fixed to *PV* transmission mode, other modes are not supported yet.

5.8.2 Transmission Output Upper / Lower Limit Value Settings [PAR4 → FsL1/ FsH1]

Setting	Description / Range	Default
FsL1	Sets the lower limit of transmission output (<i>4 mA</i>).	-200
FsH1	Sets the upper limit of transmission output (<i>20 mA</i>).	1350

If the transmission output value [**AoM 1**] is below the lower limit of the transmission output [**FsL1**], an output value of 4 mA will be present. If the transmission output is between the lower limit [**FsL1**] and the upper limit [**FsH1**], a certain proportional output value is transmitted in the range between 4 mA and 20 mA. If it exceeds the upper limit [**FsH1**], an output value of 20 mA will be present. If the upper limit of the transmitter output [**FsH1**] is equal to the lower limit of the transmission output [**FsL1**], the transmission output is 4 mA.

5.9 COMMUNICATION

This function is used by external systems (*PC, GP, PLC, etc.*) to monitor the controller. It can be used to transfer data transferred to external devices. There can be no redundant unit addresses on the same communication line. The communication cable must be a twisted pair that supports the RS485 standard.

Interface:

Type	Description
Communication protocol	Modbus RTU
Connection type	RS485
Application standard	EIA RS485 compliant
Maximum number of connections	31 unit (address: 01...99)
Synchronization method	Asynchronous
Communication method	2-wire, half-duplex
Communication distance	Max. 800 m
Communication speed	2400, 4800, 9600, 19200, 38400 bps
Communication response time	5...99 ms
Start bit	1-bit (fix)
Data bit	8-bit (fix)
Parity bit	None, odd, even
Stop bit	1-bit, 2-bit

5.9.1 Unit Address Settings [PAR4 → ADRS]

Unique addresses can be assigned to units from 1 to 99. Default setting: 1.

5.9.2 BPS (Bits Per Second) Settings [PAR4 → BPS]

Set the data transfer rate.

Parameter	Description / Range	Default
BPS	24 (2400 bps) / 48 (4800 bps) / 96 (9600 bps) / 192 (19200 bps) / 384 (38400 bps)	96 bps

5.9.3 Communication Parity Bit [PAR4 → PRTY]

This parameter enables or disables the parity bit setting. The parity bit is a data communication method that adds an additional bit to the transmitted data packet as an indicator for checking for data loss and damage. Default setting: NONE.

Setting	Description
NONE	Disables parity bit.
EVEN	Parity is even if the number of bits of value 1 in the data packet is even
ODD	The parity is odd if the number of bits of value 1 in the data packet is odd

5.9.4 Communication Stop Bit Settings [PAR4 → STP]

The number of bits can be set to indicate the end of the transmitted data series. The number of bits can be 1 or 2 bits. Default setting: 2 bits.

5.9.5 Response Timeout Settings [PAR4 → RSwt]

Set a timeout to reduce communication errors when communicating with a slow master device (PC, PLC, etc.). After setting the waiting time, the controller responds after the specified waiting time. Default setting: 20 ms.

Note: Shorter latencies may cause communication errors in the master device.

5.9.6 Enable / Disable Communication Writing [PAR4 → COMW]

This function can change the parameter settings stored in the memory with the PC, GP, PLC, etc. to enable or disable writing. Default setting: EnA.

Setting	Description
EnA	Enable parameter set / modification via communication.
DisA	Prohibit the setting or modification of parameters by communication.

Note: Parameter settings can be read even if writing them is disabled.

5.10 OTHER FUNCTIONS

5.10.1 Heating MV Monitoring

Displays the current heating *MV* during heating control or heating and cooling control. The *MV* can be set manually to control the temperature.

Measuring range: **H 0.0...H 100** (unit: %)

Note: The MV can be displayed with a moving decimal point (H99.9 → H100).

5.10.2 Cooling MV Monitoring

Displays the current cooling *MV* during cooling control or heating and cooling control. The *MV* can be set manually for temperature control.

Measuring range: **C 0.0...C 100** (unit: %)

Note: The MV can be displayed with a moving decimal point (C99.9 → C100).



5.10.3 Heating Current Monitoring [PAR1 → CT-A]

This function monitors and displays the current of the controlled heater (*load*). Unit: A.

Note: A current transformer (CT) is used to measure and display the heating (load) current. The availability of the heating current monitoring function varies by model and controller output type. For the heater-cooler model, the heater flow monitor function can be used on OUT1.

5.10.4 RUN/STOP [PAR1 → R-S]

In 'Normal' mode (*RUN*), users can manually start or stop control output. Default setting: *RUN*.

The stop command stops the control output. However, the auxiliary output is not affected by this command. This function can be enabled by configuring the parameters. In addition, the digital input buttons on the front panel (for   3 seconds) and the digital input terminals (*DI-1*) can be assigned to the [**STOP**] function.

Setting	Description
RUN	Forced control output start in STOP mode.
STOP	Forced control output stop in 'Normal' mode.

*Note: When the stop function is enabled, the front panel SV display will show STOP. The setting can be changed when the controller stopped. The stop status remains in effect even after the controller is stopped and turned on again. When the STOP mode is active, STOP MV [StMV] is present at the output. If a sensor is interrupted in STOP mode, the STOP MV [StMV] is displayed. The run / stop setting remains in effect even after the power is turned back on. If the digital input (*DI-1*) function is set to RUN / STOP [STOP], the RUN / STOP function is not possible to change by the front buttons or parameters.*

5.10.4.1 Stop Control Output Settings [PAR5 → StMV]

This parameter sets the output value of the controller when stopped. Use the ON / OFF control to select between 100 (*ON*) and 0.0 (*OFF*). With PID control, the user can set the *MV* value between 0.0 and 100.

Default setting: 0.0%.

Note: Ignores the MV of the ON / OFF control or the PID control and sends a control value based on the defined MV.

5.10.4.2 Stopping the Alarm Output [PAR5 → StAL]

Enable or disable the alarm output when the control stopped. Default setting: CONT.

Setting	Description
OFF	The alarm stops under all conditions. (However, returning to 'Normal' mode will reset the alarm output to the previous state after the alarm latch or alarm latch and standby stop.)
CONT	The alarm output continues regardless of the control.

5.10.5 Multi SV

The Multi SV feature allows users to configure multiple SVs and save all settings from SV0 to SV1. Users can change the SV-N or select the desired SV using the external digital input terminal (digital input, DI-1) function. This feature supports up to four SVs that can be configured independently.

5.10.5.1 The Number of Multi SVs [PAR5 → MtSV]

This parameter sets the number of Multi SVs ($1 = SV-0/2 = SV-0, SV-1$). Default: 1.

Note: This feature is not available for all models. If the digital input (DI-1) function is set to Multi SV [MtSV], the Multi SV number will not change by pressing the button or communicating.

5.10.5.2 Selecting the Multi SV Number [PAR1 → SV-N]

Select the SV to control. Default setting: SV-0.

Note: The number range (SV number) assigned to each SV varies depending on the setting of Multi SVs [MtSV].

5.10.5.3 Multi SV Settings [PAR1 → SV-0/ SV-1]

Select the value of each SV for the Multi SV. Default value: 0. The unit is °C / °F.

5.10.6 Digital Input

5.10.6.1 Digital Input Terminal Settings [PAR5 → DI-1]

If an external signal source is connected to a digital input terminal, one of the following functions can be set. Default setting: OFF.

Setting	Description
OFF	Not in use
STOP	Run / Stop
AIRE	Deactivate alarm output
MAN	Select automatic / manual control
MtSV	Multi SV selection

If the DI-1 is set to Multi SV [MtSV], SV-0 is selected as SV when the terminal's external contact is off and SV-1 is selected when the signal is switched on.

Note: When turned on, the digital input always checks the terminal input settings. The PGM-500 series has a limited number of terminals. Therefore, the digital input terminal1 (DI-1) is available. The Multi SV parameter is only activated if the Multi SV is at least 2. The digital input terminal function works independently of the lock and password settings [PAR5 → PWD].



5.10.6.2 Digital Input Button Setting [PAR5 → DI-K]

To use the digital input button function, all functions must be first be assigned to the buttons. Default setting: STOP.

Setting	Description
STOP	RUN / STOP
AIRE	Deactivate forced alarm output
AT	Automatic tuning RUN / OFF (for PID control)
OFF	Not used

Note: If the digital input button and the digital input terminal are set the same, the digital input button will not work.

To use the digital input button:

In "Normal" mode, press and hold the  +  buttons for 3 seconds to perform the assigned function (deactivate run / stop or alarm output).



Note: If the same function is assigned to the digital input button and the digital input terminal, it is activated as an "or" function and deactivated as an „and" function. (However, this does not apply to the Multi SV function [MtsV] of the digital input terminals.) The digital input button functions work regardless of the password settings [PAR5 → PWD].

5.10.7 User Level Settings [PAR5 → USER]

Displaying the parameters can be restricted by setting the user level (normal or high). If set to standard user, only the main function parameters shaded in the complete parameter list are only displayed. Default setting: STND.

Settings	Description
STND	Activates standard user parameters
HIGH	Activates all parameters

5.10.8 SV Group Lock [PAR5 → LcSV]

The modification of SV parameters can be restricted by locking the SV group parameters, which include SV selection, digital input button (  buttons for 3 seconds),  button for monitoring and manual control, parameter reset [INIT], and so on. Default setting: OFF.

Setting	Function
ON	Activates the SV group lock.
OFF	Disables the SV group lock.

5.10.9 Parameter Group Lock [PAR5 → LcP1/LcP2/LcP3/LcP4/LcP5]

Lock or unlock each parameter group from parameter group 1 [PAR1] to parameter group 5 [PAR5].

The parameter settings can be read even if the parameter group lock is set.



For parameter 5 [PAR5], the settings can be changed even if the [LcSV / LcP □] lock is initialized.

Default setting: OFF.

Parameter	Description
ON	Lock parameter group
OFF	Unlock parameter group

5.10.10 Reset Parameter [INIT]

This function resets all parameters in the memory to the factory defaults.

Press and hold the    buttons on the front panel front panel for 5 seconds. The [INIT] parameter is displayed. Select "YES" to reset the parameters. Default setting: NO.

Note: If the password function is enabled, a password must be entered to activate the function. Resetting the parameters also resets the password.

5.10.11 Password Settings [PAR5 → PWD]

The password setting applies to the functions in the SV group (*except for the digital input key*) and to parameters 1 to 5.

Changing the password setting automatically activates password protection. However, setting the password to 0000 disables password protection. Default setting is 0000.

0001 is a read-only password. With this setting, the user can check the parameter settings without knowing the password. However, the user cannot change the parameters. If the [PWD] parameter is accessed with a read-only password, the encrypted form of the setting is displayed.

Settings:

1. Press and hold the **MODE** button in "Normal" mode.
2. Use the **▼** **▲** buttons to select the [PAR5], then press the **MODE** button.
3. Press the **MODE** button to search the [PWD].
4. Select the desired digit with the **◀** button.
5. Use the **▼** **▲** buttons to enter the password (0000, 0002...9999), then press the **MODE** button to save.
6. Repeat steps 4 and 5 and enter the preset password.
7. Press the **MODE** button or do not press any button for at least 3 seconds to save the password

Note: 5.10.6 Digital Input functions are not affected by password protection settings.

5.10.11.1 Setting Up a Password [PASS]

If password protection is enabled, access to SV parameters or groups when the device is in 'Normal' mode requires a password confirmation parameter [PASS]. Then the correct password must be entered to access the setting parameters.

Settings:

1. Access to the SV parameter or parameter group.
2. When prompted for [PASS], use the **◀** button to select the desired digit.
3. Use **▼** **▲** buttons to enter the password (0001 to 9999), then press **MODE**.
 - If the correct password is entered, the setting parameters will be accessible.
 - If an incorrect password is entered, repeat steps 2 and 3 and enter the correct password.

Note: If the password is unknown, enter 0001 to access the parameters in read-only mode. This parameter only appears if the setting of 5.10.11 Password Settings [PAR5 → PWD] is set to a value other than 0000. If an incorrect password is entered, the SV display will show the encrypted form of the password stored by the user and an error message [ERR]. Then the error message flashes every 1 second.

5.10.11.2 Reset Password

Entering an incorrect password displays the encrypted form of the password on the SV display. Send this code to NIVELCO to recover a lost password.

Incorrect password entry (*for example, the correct password is 1234*).

1. Access to the SV parameter or parameter group.
2. When prompted by PASS, use the **◀** button to select the digit.

Use the **▼** **▲** buttons to select 4321 (*incorrect password*), then press **MODE**. Entering an incorrect password displays an encrypted password on the SV display. An ERR message is displayed and flashes at 1-second intervals.

6. ERROR CODES

The controller diagnoses the input signals for errors and displays the messages accordingly. These messages inform the user of device problems. When the input value returns to the appropriate range, the alarm is deactivated and the device returns to normal operation.

Message	Input	Description	Output
HHHH	Temperature sensor	Flashes at 0.5 second intervals when the input value is above the input range.	Standard: Heating: 0%, cooling: 100%. Heating and cooling: heating: 0%, cooling: 100%.
	Analog	Flashes every 0.5 seconds if the input value exceeds 5...10% of the upper or lower limit.	Standard output
LLLL	Temperature sensor	Flashes every 0.5 seconds if the input value is below the input range.	Standard: Heating: 100%, cooling: 0% Heating and cooling: heating: 100%, cooling: 0%
	Analog	Flashes every 0.5 seconds if the input value exceeds 5...10% of the lower or upper limit.	Standard output
OPEN	Temperature sensor	Flashes at 0.5 second intervals for input disconnection.	Sends out the set MV. [PAR5 → ErMV]
	Analog	Flashes at 0.5 second intervals when F.S. more than $\pm 10\%$.	
ERR	Temperature sensor	Flashes every 0.5 seconds when an error has occurred in the setting and returns to the screen before the error.	–

If the upper and lower limit scale settings are the same, ERR flashes twice and the "Setting" mode will be displayed.

For analog input, $\pm 5\%$ of the set upper / lower limit is extended. The analog output is also expanded by comparing the input value. (Using a $\pm 5\%$ extension within the temperature range for a temperature sensor input.)

7. MAINTENANCE, REPAIR, AND STORAGE

The device does not require regular maintenance. The warranty card contains the terms and conditions. Before returning the device for repairs, it must be cleaned thoroughly. The parts in contact with the medium may contain harmful substances; therefore, they must be decontaminated. Our official form ([Returned Equipment Handling Form](#)) must be filled and enclosed in the parcel. Download it from our website www.nivelco.com. The device must be sent back with a declaration of decontamination. A statement must be provided in the declaration that the decontamination process was successfully completed and that the device is clean from any hazardous substances.

Unused devices must be stored at $-20\dots+60$ °C ($-4\dots+140$ °F) ambient temperature and 35...85% RH ambient humidity.

WIRING

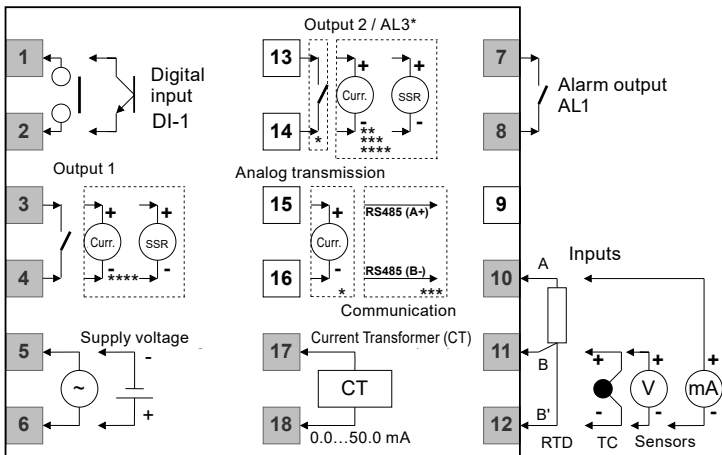

* PMG-511

** PMG-512

*** PMG-513

**** PMG-514, -515

Supply voltage

100...240 V AC 50/60 Hz 8 VA

24 V AC 50/60 Hz 8 VA

24...48 V DC 5 W

Output 1

Relay: 250 V AC 3 A AC-1 resistance load

Current: 0/4...20 mA DC max. 500 Ω

SSR: 11 V DC ±2 V max. 20 mA

Output 2

Relay: 250 V AC 3 A AC-1 resistance load

Current: 0/4...20 mA DC max. 500 Ω

SSR: 11 V DC ±2 V max. 20 mA

Current Transformer (CT)

Ratio is 1/1000

Alarm output

Relay: 250 V AC 3 A AC-1 resistance load

Analog transmission

Current: 4...20 mA DC max. 500 Ω

pmg511en24p04

May 2024

NIVELCO reserves the right to change anything in this manual without notice!

8. MENU MAP

