

**Thank you for choosing a NIVELCO instrument.  
We are sure that you will be satisfied throughout its use.**

## 1. APPLICATION

The NIVOMAG MK-200 series magnetic float level switches are used for level point detection of liquids in all type of vessels.

Operation without external power, side or top mounting, wide temperature ranges, various process connections, stainless steel wetted parts and Ex versions make it applicable in the industrial chemistry, pharmacy, petrol industry etc. Permanent magnet operated by the movement of a float will activate an other magnet inside the switching enclosure. This second magnet operates a special switch. So the movement of float is transferred to the potted switch through separated magnetic coupling ensuring the requirements of the wet process and Ex application. Special balancing construction and various accessories (see figures of DIMENSIONS) give wide range of possibility of the installation.

## 2. TECHNICAL DATA

### 2.1 GENERAL SPECIFICATION

TYPE	HORIZONTAL FLOAT				VERTICAL FLOAT
	MK□-21□-□	MK□-22□-□	MKG-2□□-□	MKS-2□□-□	MK□-23□-□
Nominal Pressure max.	2.5 MPa (MKU: 0.2 MPa / 2.5 MPa)				1.6 MPa
Liquid temperature	see temperature diagram	0°C to 100°C	0°C to 200°C	s. temp.diagr.	
Ambient temperature	-20 °C ... +80 °C, Ex version see table below				
Liquid density	min 0.7 kg/dm <sup>3</sup> ... 0.85 kg/dm <sup>3</sup> see table				
Switch differential	Fixed	Adjustable	Fixed	Fixed	Adjustable
Protrusion length	See figures below				
Material of vetted parts	SS316Ti (MKG: rubber MKS silicon rubber)				
Housing material	Paint coated aluminium				
Switch action	1 micro-switch with 1 closing and 1 opening contact (NO and NC)				
Switch rating	250 V AC12 10 A; 220 V DC13 0.6 A – Ex:250V AC12 2.5A; 220V DC13 0.3 A				
Electrical connection	1 x Pg 16 or M20 x 1.5 for cable diameter 6 to 15 mm* with 5 x 2.5 mm <sup>2</sup> wire cross section (MKU: integrated cable)				
Mechanical protection	IP 65 (MKU: IP 68 max 20 m water depth)				
Electrical protection	Class I.				
Ex protection mark	Ⓔ II 1/2 G Ex d e mb IIC T6 ... T2 Ga/Gb				
Weight (approx)	2.5 kg				

\* depending on type of cable gland

### 2.2 SPECIAL DATA

CLASS	TEMPERATURE				
	T6	T5	T4	T3	T2
Liquid temperature	+80 °C	+95 °C	+130 °C	+200 °C	+250 °C
Ambient temperature	-20 °C ... +60 °C	-20 °C ... +70 °C	-20 °C ... +80 °C	-20 °C ... +80 °C	-20 °C ... +80 °C

NIVELCO

# NIVOMAG

MAGNETING FLOATING  
LEVEL SWITCHES

## USER'S MANUAL

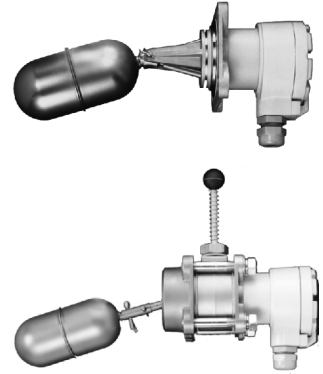

Manufacturer:   
**NIVELCO Process Control Co.**  
 H-1043 Budapest, Dugonics u. 11.  
 Phone: (36-1) 889-0100 ■ Fax: (36-1) 889-0200  
 E-mail: sales@nivelco.com ■ www.nivelco.com

ARM. L. (mm)	MINIMAL DENSITY OF LIQUID (kg/dm <sup>3</sup> )			
	0 ... 100	200	300	1000 ... 3000
FLOAT (mm)				
52	0.7	0.8	0.85	-
64	0.7	0.8	0.8	-
120	-	-	-	0.7

### 2.3. ACCESSORIES

– User's Manual, Warranty Card, Declaration of conformity

### 2.4 ORDER CODE

NIVOMAG M K □ - 2 / 3 □ □ - □ Ex

VERSION	CODE
Normal	A
Normal + rubber cup	G
Normal + silicon rubber cup	S
Under water	U
Under water + rubber cup	V
Under water + silicon rub. cup	Z

FUNCTION	CODE
Constant hysteresis	1
Adjustable hysteresis	2
Adjustable hysteresis vertical float	3

PROCESS CONNECTION	CODE
92 x 92 flange	0
DN 80 PN 25 C steel	1
DN 100 PN 25 C steel	2
DN 125 PN 25 C steel	3
DN 150 PN 25 C steel	4
DN 80 PN 25 SS 316 Ti	5
DN 100 PN 25 SS 316 Ti	6
DN 125 PN 25 SS 316 Ti	7
DN 150 PN 25 SS 316 Ti	8
2" BSP	B
2" NPT	N

ARM. LENGTH	CODE	
	Normal	Ex version
0 mm	0	9
100 mm	1	5
200 mm	2	6
300 mm	3	7
Z or L arm	4	8

### COUNTER FLANGE

NIVOMAG M F F - 1 □ □ - 0

MATERIAL	CODE
C steel	1
SS 316 Ti	2

PROC. CONNECT.	CODE
92 x 92 PN 25	0
92 x 92 PN 25 for tester	1
92 x 92 PN 25 Counter fl. spec.	2
92 x 92 PN 25 Counter flange spec. for tester	3

### TESTER

NIVOMAG M M K - 1 □ 0 - 0

MATERIAL	CODE
C steel	1
SS 316 Ti	2

### MK-23

ARM. LENGTH	CODE	
	Norm	Ex vers.
1000 mm	1	5
2000 mm	2	6
3000 mm	3	7

## 2.5 DIMENSIONS

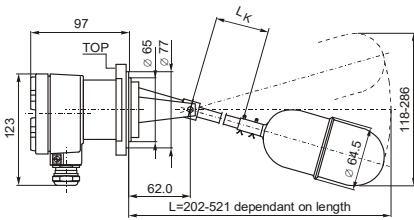

**MKA-210-0**

Fixed switch differential according to the arm length

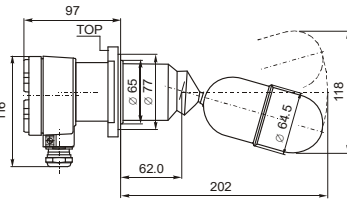

**MKG 210-□, MKS 210-□**

Fixed switch differential, with protection sleeve only non Ex versions

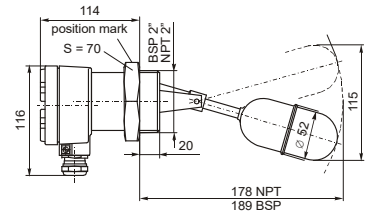

**MKA-21B**

Fixed switch differential, with 2" process connection

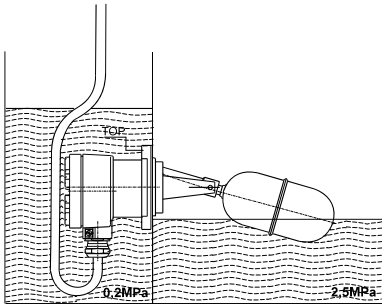

**MKU-210**

Fixed switch differential, for underwater application

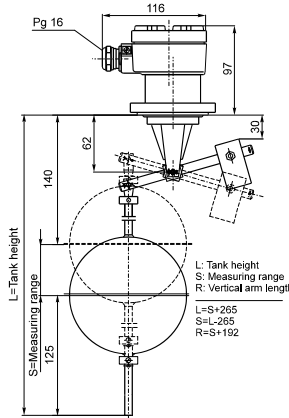

**MKA-230**

Adjustable switch differential, vertical mounting

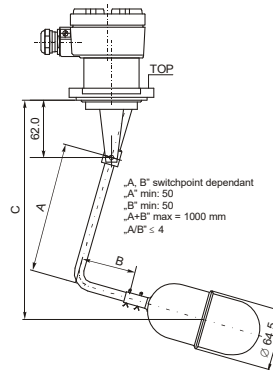

**MKA-210-4**

Adjustable switch differential, vertical mounting

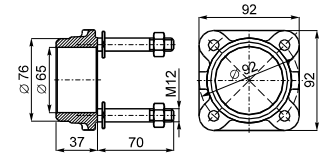

**MFF-111, 121** Counter flange for MMK tester

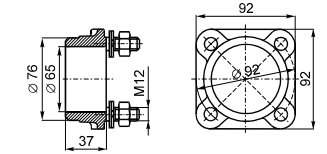

**MFF-110, 120** Square counter flange

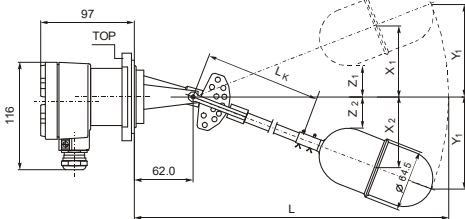

**MKA-220** Adjustable switch differential, vertical mounting

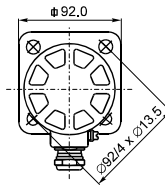

Rectangular connection flange

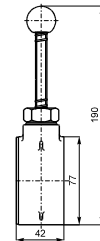

**MMK-110, 120** Tester

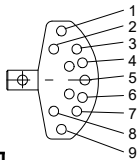

## 3. INSTALLATION

Installation according to the requested application may carry out on the basis of drawings and tables. The balance of the arms with differential length is provided by the counter weight shifted to the proper point at the vertical type MKA-23. Hysteresis switching points will be adjusted on the vertical stick with fixing rings. Function of the switch may be tested without dismantle of the instrument by the installed MMK tester. Minimal length of the arm is not shorter than 100 mm in that case.

## 4. ELECTRICAL CONNECTION

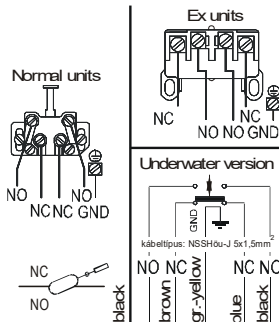

## 5. SPECIAL CONDITIONS FOR SAFE USE

- Ambient and medium temperature see 2.2.
- For installation of version NIVOMAG MKU-2□□□ Ex (with integrated cable) a suitable junction box shall be used.
- The NIVOMAG MK float switch has to be connected to local EP circuit.

Pos.	MKA-220- <sup>0</sup> <sub>-9</sub> Ex				MKA-220- <sup>1</sup> <sub>-5</sub> Ex				MKA-220- <sup>2</sup> <sub>-6</sub> Ex				MKA-220- <sup>3</sup> <sub>-7</sub> Ex							
	L <sub>k</sub> =0				L <sub>k</sub> =100				L <sub>k</sub> =200				L <sub>k</sub> =300							
	L=268				L=350				L=450				L=550							
	X <sub>1</sub>	X <sub>2</sub>	Diff S	Y <sub>1</sub> (Z <sub>1</sub> )	Y <sub>2</sub> (Z <sub>2</sub> )	X <sub>1</sub>	X <sub>2</sub>	Diff S	Y <sub>1</sub> (Z <sub>1</sub> )	Y <sub>2</sub> (Z <sub>2</sub> )	X <sub>1</sub>	X <sub>2</sub>	Diff S	Y <sub>1</sub> (Z <sub>1</sub> )	Y <sub>2</sub> (Z <sub>2</sub> )	X <sub>1</sub>	X <sub>2</sub>	Diff S	Y <sub>1</sub> (Z <sub>1</sub> )	Y <sub>2</sub> (Z <sub>2</sub> )
1-4	+87	+20	67	131	(13)	+129	+30	99	194	(19)	+171	+40	131	256	(25)	213	+50	163	319	(51)
1-5	+87	+12	75	131	44	+129	+18	111	194	87	+171	+24	147	256	36	213	+30	183	319	45
1-6	+87	-20	97	131	53	+129	-30	159	194	44	+171	-40	201	256	58	213	-50	263	319	72
1-7	+87	-42	129	131	84	+129	-62	191	194	92	+171	-82	253	256	121	213	-102	315	319	151
1-8	+87	-65	152	131	123	+129	-96	225	194	142	+171	-127	298	256	187	213	-158	371	319	233
1-9	+87	-89	176	131	131	+129	-132	261	194	194	+171	-175	316	256	256	213	-218	431	319	319
2-5	+80	+12	68	123	44	+118	+18	100	182	27	+156	+24	132	240	36	194	+30	164	299	45
2-6	+80	-20	100	123	53	+118	-30	148	182	44	+156	-40	196	240	58	194	-50	244	299	72
2-7	+80	-42	122	123	84	+118	-62	180	182	92	+156	-82	238	240	121	194	-102	296	299	151
2-8	+80	-65	145	123	123	+118	-96	214	182	142	+156	+127	283	240	187	194	-158	352	299	233
2-9	+80	-89	169	123	131	+118	-132	250	182	194	+156	-175	339	240	256	194	-218	402	299	319
3-5	+47	+12	35	84	44	+70	+18	52	104	27	+93	+24	69	137	36	+116	+30	86	171	45
3-6	+47	-20	67	84	53	+70	-30	100	104	44	+93	-40	133	137	58	+116	-50	66	171	72
3-7	+47	-42	89	84	84	+70	-62	132	104	92	+93	-82	175	137	121	+116	-102	218	171	151
3-8	+47	-65	112	84	123	+70	-96	166	104	142	+93	-127	220	137	187	+116	-158	274	171	233
3-9	+47	-83	136	84	131	+70	-132	201	104	194	+93	-175	268	137	256	+116	-218	334	171	319
4-6	+20	-20	40	53	53	+30	-30	60	78	44	+40	-40	80	103	58	+50	-50	100	128	72
4-7	+20	-42	62	53	84	+30	-62	92	78	92	+40	-82	122	103	121	+50	-102	152	128	151
4-8	+20	-65	85	53	123	+30	-96	126	78	142	+40	-127	167	103	187	+50	-158	208	128	233
4-9	+20	-89	109	53	131	+30	-132	162	78	194	+40	-175	215	103	256	+50	-218	268	128	319
5-7	-12	-42	30	44	84	-18	-62	44	65	92	-24	-82	106	86	121	-30	-102	72	107	151
5-8	-12	-65	53	44	123	-18	-96	78	65	142	-24	-127	151	86	187	-30	-158	128	107	233
5-9	-12	-89	72	44	131	-18	-132	115	65	194	-24	-175	189	86	256	-30	-218	188	107	319
6-9	-20	-89	69	13	131	-30	-132	102	13	194	-40	-175	215	23	256	-50	-218	168	31	319

- The NIVOMAG MK float switch has to be protected against overload with a "T" marked 2.5 A circuit breaker
- For T<sub>amb</sub> > 60 °C a suitable cable shall be used.

## 7. STORAGE CONDITIONS

Environmental temperature range: 25°C to +80°C Relative humidity: max. 98 %

## 6. MAINTANCE, REPAIR

The NIVOMAG MK-200 series devices do not require maintenance on a regular basis. In some instances, however, the device may need a cleaning from deposited material. Repairs during or after the guarantee period are effected at the Manufacturer's premises.

mka210en1811h

Jan, 2018

Technical specification may be changed without notice.