

staffe per sensori R e E mounting brackets for sensors series R and E

26.558.0

- cilindri senza stelo OPL
[rodless cylinders series OPL]
- cilindri corsa breve serie D
[short stroke cylinders series D]

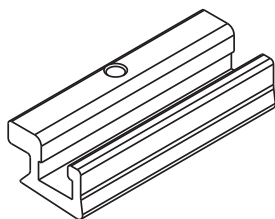
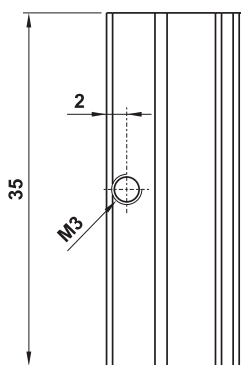
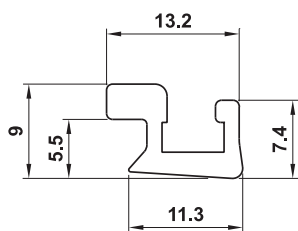

26.559.0

- microcilindri ISO 6432 \varnothing 8-25
[minicylinders ISO 6432 \varnothing 8-25]

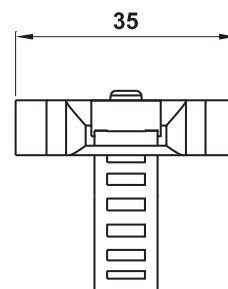
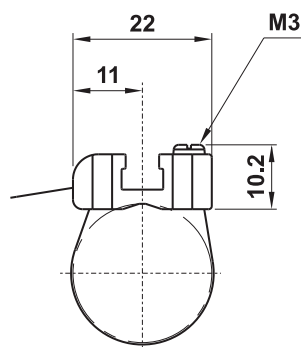
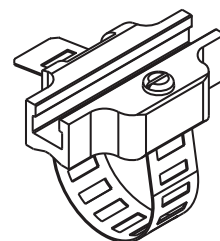

26.560.0

- cilindri tondi \varnothing 32-63
[round cylinders \varnothing 32-63]

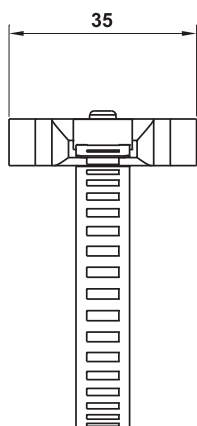
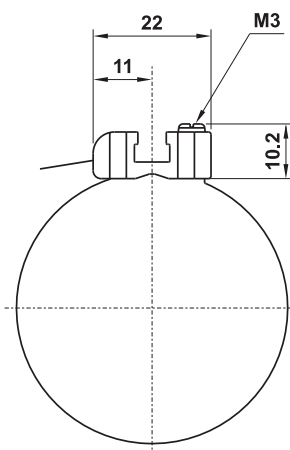
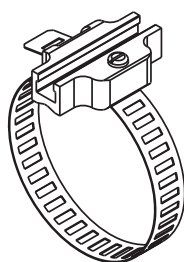

26.561.0

- tiranti \varnothing 5-19 per cilindri ISO 6431
[tie-rods \varnothing 5-19 for cylinders ISO 6431]

