

# NIVOCAP

C-200, C-200 Ex, C-300  
Two-wire compact capacitance  
level transmitter

Installation and programming manual  
5<sup>th</sup> edition



Manufacturer:

NIVELCO Process Control Co.

H-1043 Budapest, Dugonics u. 11.

Tel.: (36-1) 889-0100 ■ Fax: (36-1) 889-0200

E-mail: sales@nivelco.com ■ www.nivelco.com



1418

# CONTENTS

<b>1. INTRODUCTION .....</b>	<b>4</b>	<b>5. PROGRAMMING .....</b>	<b>13</b>
<b>2. ORDER CODE (NOT ALL COMBINATIONS POSSIBLE!) .....</b>	<b>5</b>	<b>5.1. PROGRAMMING WITHOUT DISPLAY MODULE .....</b>	<b>14</b>
<b>2.1. ACCESSORIES .....</b>	<b>6</b>	<b>5.2. PROGRAMMING WITH THE SAP-202 DISPLAY MODULE .....</b>	<b>17</b>
<b>3. TECHNICAL DATA .....</b>	<b>7</b>	5.2.1 Volume programming .....	17
<b>3.1. SPECIAL DATA FOR EX CERTIFIED MODELS.....</b>	<b>8</b>	5.2.2 SAP-202 display module .....	18
<b>3.2. SPECIAL CONDITIONS FOR SAFE USE .....</b>	<b>8</b>	5.2.3 Steps of the programming .....	18
<b>3.3. SAP-202 DISPLAY MODULE.....</b>	<b>8</b>	5.2.4 Indications of the SAP-202 Programming Module and the LEDs .....	20
<b>3.4. DIMENSIONS.....</b>	<b>9</b>	5.2.5 QUICKSET .....	21
<b>3.5. ACCESSORIES.....</b>	<b>10</b>	5.2.6 Full parameter programming .....	23
<b>3.6. MAINTENANCE AND REPAIR .....</b>	<b>10</b>	<b>6. PARAMETERS – DEFINITIONS AND PROGRAMMING .....</b>	<b>24</b>
<b>4. INSTALLATION .....</b>	<b>11</b>	<b>6.1. MEASUREMENT CONFIGURATION .....</b>	<b>24</b>
<b>4.1. MOUNTING AND WIRING .....</b>	<b>11</b>	<b>6.2. CURRENT OUTPUT.....</b>	<b>27</b>
<b>4.2. CHECKING OF THE LOOP CURRENT .....</b>	<b>12</b>	<b>6.3. MEASUREMENT OPTIMALISATION.....</b>	<b>28</b>
		<b>6.4. VOLUME MEASUREMENT .....</b>	<b>28</b>
		<b>6.5. 32-POINT LINEARISATION .....</b>	<b>29</b>
		<b>6.6. SERVICE PARAMETERS (READ ONLY) .....</b>	<b>31</b>
		<b>6.7. TEST PARAMETERS .....</b>	<b>31</b>
		<b>6.8. SIMULATION .....</b>	<b>32</b>
		<b>6.9. ACCESS LOCK .....</b>	<b>32</b>
		<b>7. ERROR CODES.....</b>	<b>33</b>
		<b>8. SUMMARY OF THE PARAMETERS.....</b>	<b>35</b>

# CAPACITANCE LEVEL MEASUREMENT

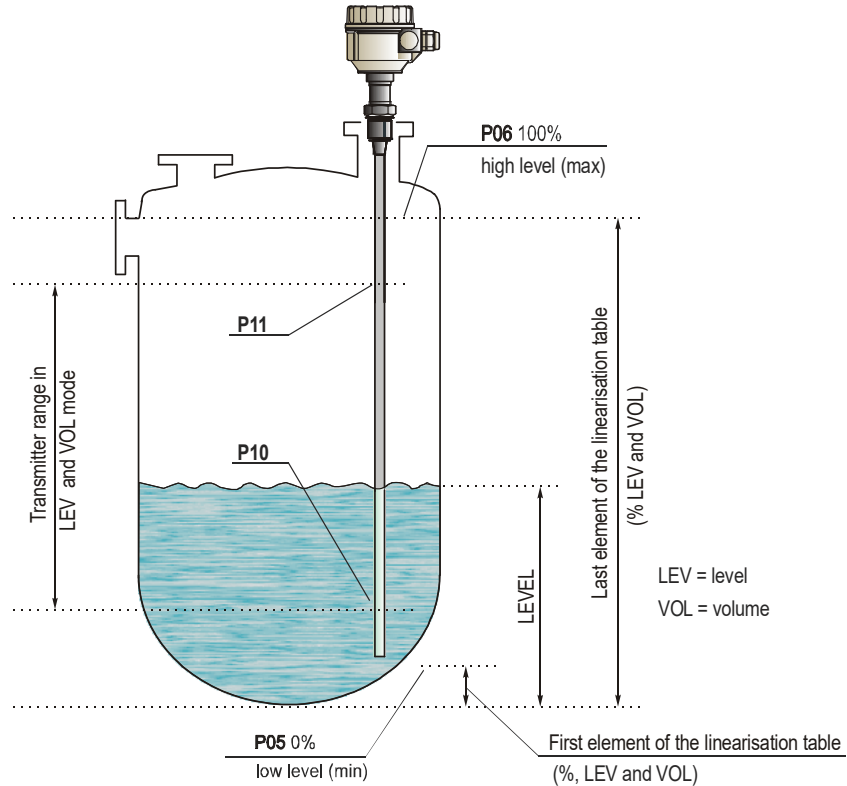

*Thank you for choosing a NIVELCO instrument  
We are sure that you will be satisfied throughout its use*

## 1. INTRODUCTION

NIVOCAP CT-200 is a two-wire capacitance level transmitter for measuring level and volume (weight) of conductive or not-conductive liquids or free flowing solids.

### APPLICATION

The active probe of the unit and the conductive wall of the vessel (or a grounded reference probe if the wall is not conductive) make up the plates of a capacitor. Insulator of the probe, surrounding air or the material in the tank provide dielectric material.

If the tank is empty the basic capacitance is  $C_0$  while the dielectric coefficient " $\epsilon_r$ " of the air is 1. If the air will be replaced by material with higher dielectric constant than that of the air, the capacitance will be changed, i.e. capacitance will increase with rising material. This change of the sensed capacitance converted to output signal will be proportional to the level change. The same time the condition of level gauging is direct proportionality between the level change and the change of the capacitance.

The value of capacitance also depends on the distance between the plates, the condition above will be met if the active probe is parallel to the tank wall or with the reference probe. Thus reference probe should be used in a tank with unusual shape or cylindrical tank in a horizontal position even if the wall is conductive, provided the medium is not conductive.

Due to the level measurement on the capacitance principle it is essential to measure and store capacitance at two different levels in the tank (teaching), when the unit is "learning" surrounding conditions of the actual application (e.g.  $C_0$  is different on the workshop bench and on site in the tank etc.).

Improper selection of the probe and very low dielectric constant may prevent the measurement.

For conductive materials (e.g.. water, acid., bases, solutions with water, etc.) insulated active probes should be used., while value of the dielectric constant is indifferent. Both insulated and uninsulated probes can be used for non conductive materials but dielectric constant must be over 1.5 ( $\epsilon_r > 1.5$ ).

### VOLUME AND WEIGHT MEASUREMENT

This measurement is supported by the volumetric calculation feature and arithmetical formula for the most commonly used tank shapes in the software. Thus measuring level, volume or weight of the medium in the tank can be transmitted and displayed.

### LINEARISATION

If there is no direct proportionality between the change of capacitance and change of level the 32-point linearisation feature should be applied. Linearisation is the method of assigning calibrated volume values to level values measured by the unit.



## 2.1. ACCESSORIES

- HART modem SAT-304
- Display module SAP-202
- Weight for cable probe CTK-103-0M-40001
- Reference (tube) probe

NIVOCAP C   - 1   - 0

VERSION / THREAD	CODE
Coaxial tube BSP	A
Coaxial tube NPT	D
Reference rod BSP	F
Reference rod NPT	E

REF. PROBE	CODE
Tube 1½"	F
Rod 1"	P

INSERTION LENGTH			
CODE	ROD / TUBE		CODE
0	0 m	0 m	0
1	1 m	0.1 m	1
2	2 m	:	:
3	3 m	:	:
		0.9 m	9

### 3. TECHNICAL DATA

TYPE		ROD PROBE	CABLE PROBE
Measurement range		0.2 ... 3 m	1 ... 20 m
Material of wetted parts	Threaded process connection	1.4571 stainless steel	
	Probe	Fully or partially PFA coated 1.4301 stainless steel rod	Fully or partially FEP coated stainless steel cable
Housing material		Paint coated aluminium (EN AC-42000) or plastic (PBT)	
Medium temperature (see: temperature diagram)		Normal type: -30 °C ... +130 °C, high temperature type: - 30 °C ... +200 °C, Ex version high temperature type: -30 °C ... +190 °C	
Pressure (see: pressure diagram)		max. 4 MPa (40 bar) at +20 °C	max. 1.6 MPa (16 bar)
Ambient temperature (see: temperature diagram)		-25 °C ... + 70 °C	
Maximum tensile force		-	7.7 kN
Saturation capacitance of the probe		~600 pF/m	~200 pF/m
Output		Analogue: 4 – 20 mA, 2-wire (3.9 ... 20.5 mA), $R_{\max} = U_i - 11.4 \text{ V} / 0.02 \text{ A}$ galvanic isolation, protection against surge transients	
		SAP-202 display module: 6- digit LCD, engineering units and bargraph	
		Digital communication: HART, terminal resistance $\geq 250 \Omega$	
Voltage output for current test		Voltage measurement on a resistor in series: 10 mV / 1 mA	
Capacitance range		0 pF ... 5 nF	
Range of transmitted capacitance		10 pF, or 10% (min. SPAN)	
Damping time		0, 3, 6, 10, 30, 60, 100, 300 s	
Error indication		Blinking of COM and VALID LED or transmitting 3.8 or 22 mA error indication current selected by programming	
Power supply / current consumption		12 ... 36 V DC, max. 22 mA / 48 ... 800 mW	
Accuracy		$\pm 0.3 \%$ (related to the length of the probe)	
Temperature coefficient		$\pm 0.02\% / ^\circ\text{C}$	
Electrical connection		M20x1.5 plastic cable gland for $\varnothing 6 \dots 12 \text{ mm}$ cable or, M20x1.5 metal cable gland for $\varnothing 7 \dots \varnothing 13 \text{ mm}$ cable, wire cross section: 0.5 ... 1.5 mm <sup>2</sup> 2 x internal thread for 2x 1/2" NPT cable protective pipe	
Process connection		3/4" and 1" NPT or BSP external (male) thread	
Ingress protection		Probe: IP68, Housing: IP67	
Electrical protection		Class III.	
Mass		2.3 kg with 0.5 m probe	1.9 kg with 3 m probe

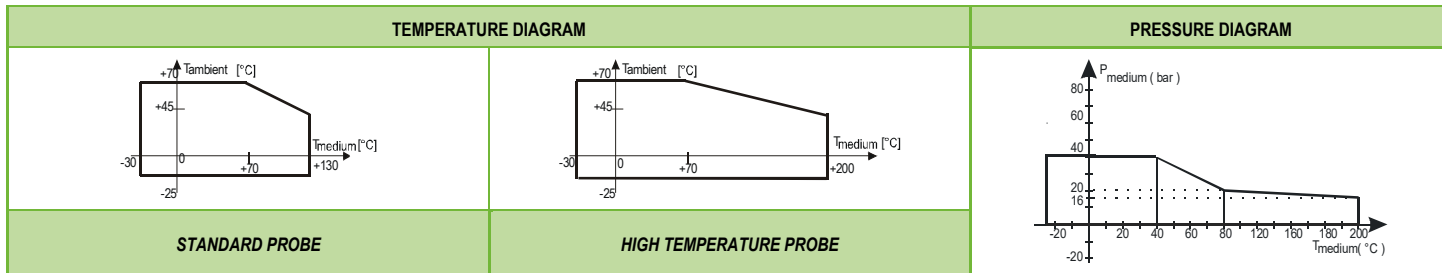

### 3.1. SPECIAL DATA FOR Ex CERTIFIED MODELS

Ex marking	Ⓔ II 1 G Ex ia IIB T6...T3 Ga
Intrinsically safe data	$C_i \leq 15 \text{ nF}$ , $L_i \leq 200 \text{ } \mu\text{H}$ , $U_i \leq 30 \text{ V}$ , $I_i \leq 140 \text{ mA}$ , $P_i \leq 1,0 \text{ W}$

### 3.2. SPECIAL CONDITIONS FOR SAFE USE

- Intrinsically safe units can only be used in certified intrinsically safe loops powered by an Ex ia IIB certified power supply with the previously given technical data.
- The tank and the level transmitter should be connected to an EP network with copper wiring  $q \geq 4 \text{ mm}^2$ .
- The electronic circuitry of the level transmitter is grounded, therefore an equipotential network should be created in case of intrinsically safe loops. Distance between the transmitter and the intrinsically safe power supply (placed outside of the hazardous area) should not exceed 100 m.

TEMPERATURE CLASS TABLE		
Temperature class	T6...T4	T3
$T_{\text{ambient}}$	70 °C	45 °C
$T_{\text{medium}}$	80...120 °C	190 °C

### 3.3. SAP-202 DISPLAY MODULE

Display	6 digit LCD, engineering units and bargraph
Ambient temperature	-25 °C ... +70 °C
Enclosure	PBT glass fibre reinforced plastic (DuPont®)

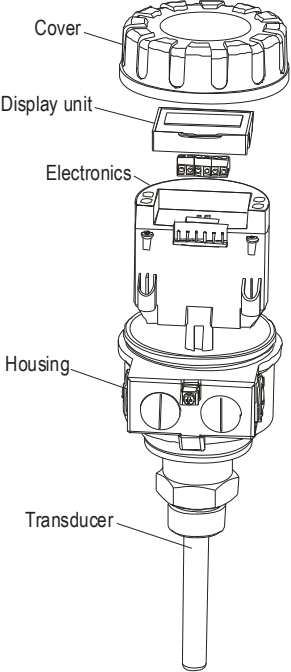
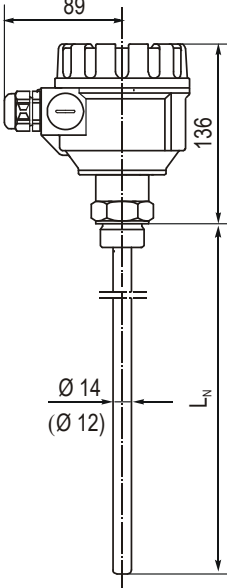
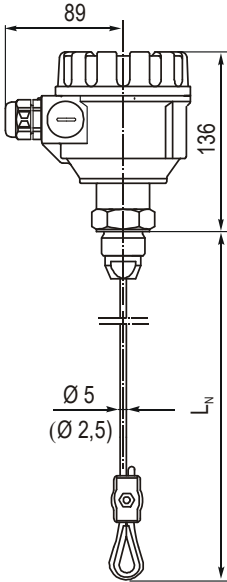
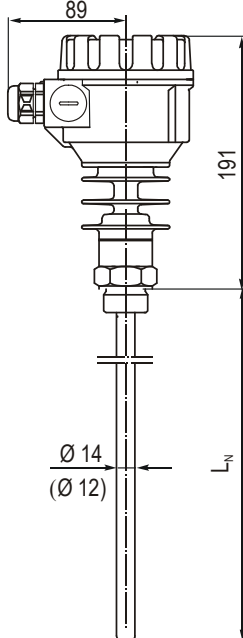

### 3.4. DIMENSIONS

<b>ROD PROBE</b> <b>CT□-2, 3□□-□</b> <b>CB□-2, 3□□-□</b>	<b>CABLE PROBE</b> <b>CT□-2, 3□□-□</b> <b>CB□-2, 3□□-□</b>	<b>HIGH TEMPERATURE ROD PROBE</b> <b>CH□-2□□-□</b> <b>CP□-2□□-□</b>	
			<p>Cover</p> <p>Display unit</p> <p>Electronics</p> <p>Housing</p> <p>Transducer</p>

<b>DISPLAY MODULE</b> <b>SAP-202</b>	<b>HART MODEM</b> <b>SAT-304</b>	<b>REFERENCE (TUBE) PROBE</b> <b>C0F-1000-0</b>

### 3.5. ACCESSORIES

- Warranty Card
- Installation and Programming Manual
- Declaration of Conformity
- 2 pcs M20x1.5 cable gland

### 3.6. MAINTENANCE AND REPAIR

The unit do not require regular maintenance.

Repairs during or after the warranty period are effected at the Manufacturers. The equipment sent back for repairs should be cleaned or neutralised (disinfected) by the User.

## 4. INSTALLATION

### 4.1. MOUNTING AND WIRING

The probe has to be installed vertically and for non-conductive materials reference probe should be used.

The NIVOCAP probes are mounted by 1" or 1½" process connections using S = 41 or S = 55 open end wrench, respectively.

It is recommended to fix the bottom end of the cable probes. This can be accomplished by fixing the cable loop or bore hole to the tank bottom or by the use of weight.

The active probe and the reference probe should be installed parallel and next to each other.

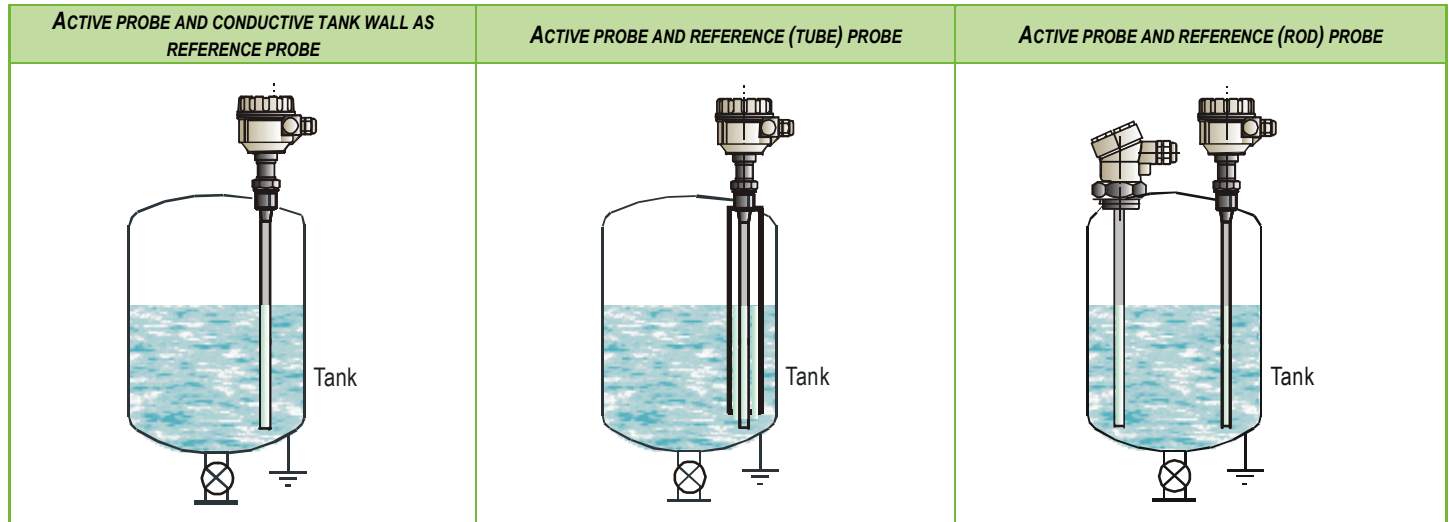

## TEMPERATURE

Electronics of the unit should be protected with shelter against development of too high temperature by direct sunshine.

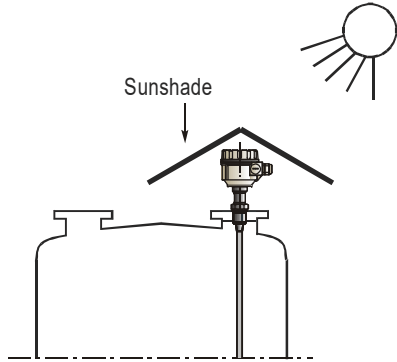

## WIRING

- Power must be switched off before wiring the unit.
- This instrument use electronic components that may be damaged by static electricity thus apply precautions commonly used e.g. touching a properly grounded point before removing cover of the enclosure
- After removal of the cover of the housing and taking out the display module (if any), the screw terminals can be accessed. Suggested cable core cross section 0.5 ... 1.5 mm<sup>2</sup>. The unit has first to be grounded by the inner or outer grounding screw.
- After connecting the cable and unit programmed proper sealing and closing should be ensured.

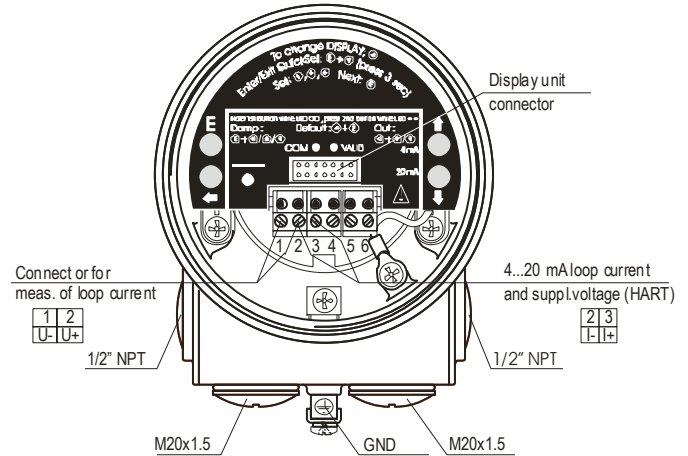

## 4.2. CHECKING OF THE LOOP CURRENT

After removal of the cover of the housing and taking out the display module (if any), voltage measuring instrument should be connected to the test connector. Setting range to 200 mV the loop current can be measured with an accuracy of ~ 0.5%.

## 5. PROGRAMMING

Since NIVOCAP is not measuring level directly, the basic element of the programming is measurement (learning) at two different levels during which the instrument is learning conditions of the actual application (shape of the tank, medium to be measured, etc.). To reach accuracy given in the table of the Technical Data these two levels should be possibly near to both end of the (rod or cable) probes (See Operation and Programming of NIVOCAP on page 4)

Learning will be represented (with Programming Without Display Module 5.1 and with QUICKSET) by the adjustment of 4 and 20 mA better to say assignment of 0% and 100% to these two output values respectively. In units without display module level will be proportional to the output current while QUICKSET programming will make possible display in % only.

If level, level in percentage, volume or volume percentage should be measured ( $a \neq 0$  in **P01**) and measured values should be displayed in engineering units of the length [e.g.. m] and volume [e.g. m<sup>3</sup>] two data pair of the linearisation table (0% and relevant minimum level in e.g. in m as well as 100% and the relevant maximum level should be entered. Linearisation should be disabled. (See **P47** and **P48** on page 30).

Not only the minimum (0%) and maximum (100%) level of the actual application can be assigned (directly) to the 4 and 20 mA output.

If for some reasons of the technology the tank can not be filled to the maximum or emptied to the minimum level the 4 and the 20 mA can indirectly also be assigned to the minimum (0 %) and maximum (100 %) with the help of two intermediate levels (say to 15% and to 80%).

Obviously - for the sake of accuracy – it is advised to fill/empty the tank to the maximum/minimum level and perform “direct” assignment as soon as possible.

The unit can also be programmed for inverse operation (4 mA = full and 20 mA = empty).

- **Programming without display module** (See 5.1)

The transmitter is fully operable without display module. Basic parameters such as assignment of 4 and 20 mA to the minimum and maximum level, fault indication by the output current and damping can be programmed

- **Programming with SAP-202 display module** (See 5.2)

- **QUICKSET** – 4 parameters can be programmed (See 5.2.4). Programming of the basic parameters will be aided by images on the display. **Measured values can only be displayed in percentage.**

- *Full parameter programming* (See 5.2.5.). All parameters and programming features of the unit can be accessed such as (measurement configuration, outputs, measurement optimisation, 11 pre-programmed tank shapes for volume calculation, 32 point linearisation.

- **Measured values can be displayed in engineering units**

The unit will measure during programming in accordance with the previous parameters. The new, modified parameters will only be effective after returning to the Measurement Mode

If the transmitter is left in Programming Mode by mistake, it will automatically return to Measurement Mode after 30 minutes and will operate with the parameters entered during the last programming completed.

### FACTORY DEFAULT

Current output and bargraph is proportional to the (capacitance) level percentage. 4 mA and 0% is assigned to the 0 capacitance percentage (low level). 20 mA and 100% is assigned to 100% capacitance (high level). Current output of the fault indication is 22 mA. Damping: 10 sec.

Note: the 4 and 20 mA assignment is an absolute necessity of the programming.

## 5.1. PROGRAMMING WITHOUT DISPLAY MODULE

### PROGRAMMING FEATURES

- 4 mA output current (direct) assignment to the minimum (0%) level
- 20 mA output current (direct) assignment to the maximum (100%) level
- 4 mA output current (indirect) assignment to the minimum (0%) level by means of an intermediate level
- 20 mA output current (indirect) assignment to the maximum (100%) level by means of an intermediate level
- Fault indication by the current output: 3.8 mA; or 22 mA
- Damping (3 sec, 10 sec, 60 sec)
- Reset to the Factory Default

Remark: current output can be programmed for inverse operation: 4 mA = 100%(full), 20 mA = 0% (empty)

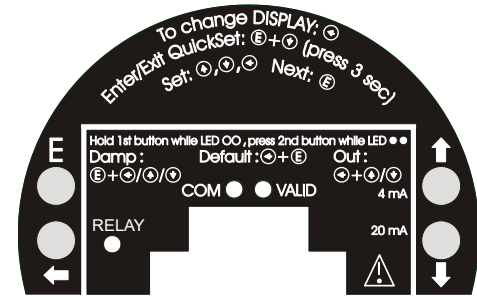

**Procedure of programming:** press programming keys in the proper sequence and watch state of the LEDs. See interpretation of the LEDs below  
 ○ = LED "Off", ● = LED Blinking, ●● = LED "On" lit, ●○ = LED-s blinking alternatively ⊗ = Do not care

**"Direct" assignment of 4 mA to the minimum level, 0%** (or maximum level for inverse operation)

Fill the tank to the minimum (maximum) level

PROGRAMMING STEPS	LED STATE AFTER PROGRAMMING STEP
1) Press key [Left Arrow] and keep it pressed	○○ = NIVOCAP in programming mode
2) Press additionally key [Down Arrow] and keep it pressed	●● = Assignment of 4 mA to the level in the tank
3) Release both keys	○○ = Programming completed

**"Direct" assignment of 20 mA to the maximum level, 100%**, (or minimum level for inverse operation)

Fill the tank to the maximum (minimum) level

PROGRAMMING STEPS	LED STATE AFTER PROGRAMMING STEP
1) Press key [Left Arrow] and keep it pressed	○○ = NIVOCAP in programming mode
2) Press additionally key [Down Arrow] and keep it pressed	●● = Assignment of 20 mA-to the level in the tank
3) Release both keys	○○ = Programming completed

### Indirect assignment of the minimum and maximum level to the output current with partially filled tank

For this programming the output current is to be measured on the test points as described in 4.2. Should higher accuracy be needed the current meter should be inserted in the 4 ... 20 mA loop.

Assuming a tank filled up to 15% approximately and the task is to accomplish "indirect" assignment of low level to 4 mA the procedure is the following. Since the current output at the level of 15% is  $I_{out} = (16 \text{ mA} \times 0.15) + 4 \text{ mA} = 6.4 \text{ mA}$  the current output should be changed with the keys  $\uparrow$ ,  $\downarrow$ , until the value of 6.4 appears on the current meter.

This procedure should be repeated with another, higher level for indirect assignment of 20 mA to the maximum level.

Obviously – for the sake of greater accuracy (it is not even sure whether the assumption of 15% is correct) – the "direct" assignment should be accomplished as soon as it is possible

#### "Indirect" assignment of 4 mA to the minimum level with partially filled tank







PROGRAMMING STEPS	LED STATE AFTER PROGRAMMING STEPS
1) Press key $\downarrow$ and keep it pressed	$\circ\circ$ = NIVOCAP in programming mode
2) Press additionally key $\text{E}$ and keep it pressed, then release keys	$\bullet\bullet$ = 4 mA in programming mode
3) Set output current with keys $\uparrow$ , $\downarrow$ to the required value Save adjustment with key $\text{E}$ or with key $\leftarrow$ you can return to the value of 4 mA	$\bullet\bullet$ = 4 mA in programming mode
4) Release the key	$\circ\circ$ = Programming completed

#### "Indirect" assignment of 20 mA to the maximum level with partially filled tank







PROGRAMMING STEPS	LED STATE AFTER PROGRAMMING STEPS
1) Press key $\downarrow$ and keep it pressed	$\circ\circ$ = NIVOCAP in programming mode
2) Press key $\leftarrow$ and keep it pressed, then release keys	$\bullet\bullet$ = 20 mA in programming mode
3) Set output current with keys $\uparrow$ , $\downarrow$ to the required value	$\bullet\bullet$ = 20 mA in programming mode
4) Save adjustment with key $\text{E}$ or with key $\leftarrow$ you can return to the value of 20 mA	$\bullet\bullet$ = 20 mA in programming mode
5) Release the key	$\circ\circ$ = Programming completed

### Selecting “Fault indication” by the current output





As a result of the programming current output will be 3,8 mA; 22 mA.

PROGRAMMING STEPS	LED STATE AFTER PROGRAMMING STEPS
1) Press key  and keep it pressed	 = NIVOCAP in programming mode
2) Press additionally key  , or  and keep it pressed	 = - 3.8 mA - 22 mA
3) Release both keys	 = Programming completed



### Adjustment of DAMPING

PROGRAMMING STEPS	LED STATE AFTER PROGRAMMING STEPS
1) Press key  and keep it pressed	 = NIVOCAP in programming mode
2) Press additionally key  , or  , or  and keep it pressed	 = - 3 sec - 10 sec - 60 sec
3) Release both keys	 = Programming completed

### Return to DEFAULT

PROGRAMMING STEPS	LED STATE AFTER PROGRAMMING STEPS
1) Press key  and keep it pressed	 = NIVOCAP in programming mode
2) Press key  and keep it pressed	 = loading DEFAULT

### Indication of programming error with the LED

PROGRAMMING STEPS	LED STATE AFTER PROGRAMMING STEPS = FAULT INDICATED	CORRECTION
Any programming attempt	 = blinking twice = no stable surface	Wait for stable surface
Any programming attempt	 = blinking three times = no access possible	With SAP-202-only see 5.2 (P99)
Any programming attempt	 = blinking four times = NIVOCAP not in default	With SAP-202-only see 5.2 (P01)



## 5.2. PROGRAMMING WITH THE SAP-202 DISPLAY MODULE

The NIVOCAP should be adjusted to the process by programming the parameters. The SAP-200 Display Module can be used to display the parameters while programming and measurement values during measurement. The SAP-200 supports two separately accessible programming modes as below.

### **QUICKSET (See 5.2.5)**

This feature is for quick programming of the 4 basic parameters like with programming without display module but aided by images on the display.

Measured values can only be displayed in percentage.

- Assignment of min level to 4 mA
- Assignment of max level to 20 mA
- Damping
- Fault indication by the current output

### **Full parameter programming (See 5.2.6)**

Highest level programming with availability of all parameters and features such as:

- Measurement configuration
- Adjustment of outputs
- Measurement optimisation
- 11 pre-programmed tank shapes for volume calculation
- 21 pre-programmed formula for flow metering

#### **5.2.1 VOLUME PROGRAMMING**

**Procedure 1:** when the level and the tank dimensions are known.

Linearisation table is disabled (P47=0) but the first two datapairs have to be entered in the linearization table (P48)

1<sup>st</sup> datapair: for 0% the minimum level value (in measurement units)

2<sup>nd</sup> datapair: for 100% the maximum level value (in measurement units)

As in this case the transmitter calculates the volume based on a volume formula the tank parameters have to be set in parameters P40-P45.

**Procedure 2:** when the level – volume relationship is known.

Linearisation table is enabled (P=47=1) and linearization table (P48) has to be filled in with known volume values belonging to different levels. The table must contain the values for 0% and 100% level in every case.

## 5.2.2 SAP-202 DISPLAY MODULE

### Symbols used on the LCD:

- **LEV** – Level measurement mode
- **VOL** – Volume measurement mode
- **PROG** - Programming mode
- **FAIL** - Measurement / device error
- **↑↓** - Level changing direction
- Bargraph assigned to the level or volume



### Symbols used on the frame:

- **M** – Metric (European) system
- **US** – US (Anglo-Saxon) system

### LED is lit

- **COM** – digital (HART) communication
- **VALID** – value within the valid range

## 5.2.3 STEPS OF THE PROGRAMMING

Programming will be performed by pressing and releasing the relevant one or two keys (simultaneously). Find a short overview of the programming while detailed descriptions are under 5.2.5 and 5.2.6.

### Single key pressing

- Ⓔ : Selection of address and step to the value of the parameter  
Selection of the parameter value and step back to the address
- ⌂ : To move the blinking of the digit to the left
- ⬆ : Increasing value of the blinking digit
- ⬇ : Decreasing value of the blinking digit

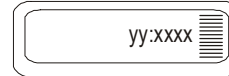

**yy** Parameter address  
(P01, P02...P99)  
**xxxx** Parameter value (**dcb**a)

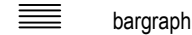

bargraph

## Double key pressing

Press the two keys simultaneously for desired programming step

### Entering/quitting programming mode

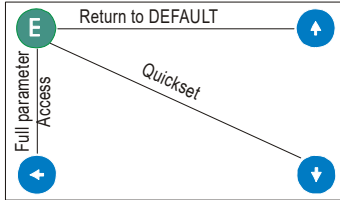

### Basic steps while parameter address is blinking

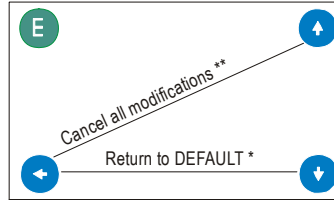

\* LOAD readout \*\* CANCEL readout

### Basic steps while parameter value is blinking

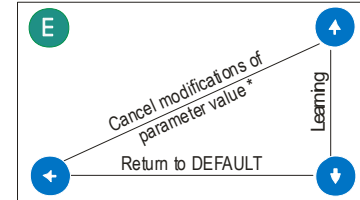

\* cancellation immediately active

### Notes:

If the parameter value is not accessible i.e. the parameter address keeps blinking after pressing ENTER (E),

- the parameter is either a read-out type, or
- the secret code prevents the modification (see **P99**).

If the modification of the parameter value is not accepted i.e. the parameter value keeps blinking after pressing ENTER (E),

- the modified value is either out of the range, or
- the code entered is not valid for this parameter

## 5.2.4 INDICATIONS OF THE SAP-202 PROGRAMMING MODULE AND THE LEDs



### SAP-202 indications

Depending on the measurement one of the below symbols will lit and the process value displayed (see **P01** chapter 6.1). Engineering units will be indicated directly or by the lit arrow showing towards them on the frame

- % percentage
- LEV level
- VOL volume
- FAIL (blinking) Error code displayed

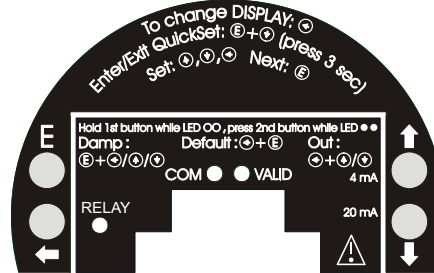

The following process values can be displayed

- Volume– if programmed so
- Level – if programmed so
- Warning indications – FAIL blinking

If the **FAIL** LED is ON the code of the error can be displayed and the output current will be in accordance with the Fault indication

If the **FAIL** LED is blinking the code of the error can be displayed and the output current will be in accordance with the measured value.

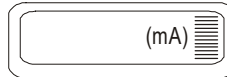

Actual current output value can be displayed by pressing DOWN (↓).

### LED indication

- **VALID-LED**
  - lit, in case the measured value is stabilized
  - blinking, in case the measured value is changing
- **COM-LED**
  - blinking when HART message is transmitted or received
  - lit, in case the transmitter is in remote programming mode

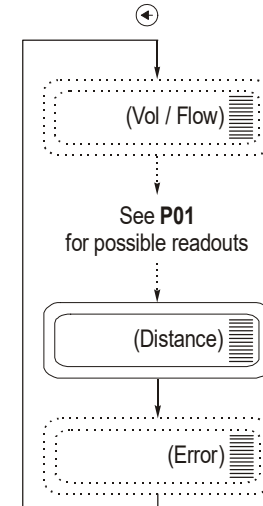

## 5.2.5 QUICKSET



### Suggested for simple applications

Quick programming of the 4 basic parameters (like with programming without display module but) aided by images on the display. Measured values can only be displayed in percentage.

QUICKSET can only be used in (%) (DEFAULT) mode (See **P01** in Full Parameter Programming 5.2.6).

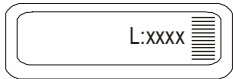
Keys	Function
Ⓔ + Ⓣ (min. 3 s)	Enter/Quit QUICKSET programming mode
Ⓢ + Ⓣ	LEARNING function
Ⓢ, Ⓣ, Ⓛ	Adjustment of digit value (increase, decrease) moving blinking
Ⓔ	Saving displayed value and step to the next screen
Ⓛ + Ⓢ	Reload value before modification (CANCEL)
Ⓔ + Ⓢ (min 3 s)	Return to DEFAULT
Ⓛ + Ⓣ	Display DEFAULT

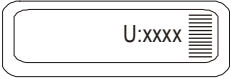
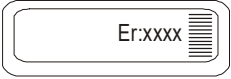
Screens	Actions
	<p><b>Assignment of 4 mA to the minimum level , %</b></p> <p>Fill the tank to the level required. After entering the Quickset programming mode the learning function can be started with the double key pressing Ⓢ + Ⓣ. During learning the image „Store” is displayed.</p> <p>The parameter value represents filling in %.</p> <p>“Indirect” assignment of 4 mA to the minimum level with partially filled tank:</p> <p>Following learning enter the momentary % value of level with the Ⓢ Ⓣ buttons.</p> <p>The output current will be set in accordance % value.</p>

Screen	Actions
	<p><b>Assignment of 20 mA to the maximum level , %</b>            Fill the tank to the level required. After entering the Quickset programming mode the learning function can be started with the double key pressing <math>\uparrow</math> + <math>\downarrow</math>. During learning the image „Store” is displayed.            The parameter value represents degree in %. “Indirect” assignment of 20 mA to the maximum level with partially filled tank:            Following learning enter the momentary % value of level with the <math>\uparrow</math> <math>\downarrow</math> buttons. The output current will be set in accordance % value.</p>
	<p><b>“Error indication” by the output current</b>            Pressing <math>\uparrow</math> or <math>\downarrow</math> either of two outputs can be selected: Indication of “3,8” or “22” should apply for 3,8 or 22 mA current output            DEFAULT 22 mA</p>
	<p><b>Damping</b> – To select damping keys <math>\uparrow</math> / <math>\downarrow</math> should be used            DEFAULT 10 sec</p>

- Note:**
- Current output can also be programmed for inverted operation: 4 mA = 100% (Full), 20 mA = 0% (Empty)
  - Description of failures can be found under 7 Error Codes.

## 5.2.6 FULL PARAMETER PROGRAMMING

Full Parameter Access is the highest programming level to access all features provided by the NIVOCAP, level, volume and weight can also be displayed in engineering units.

Description of the parameters can be found under 6. paragraph.

Keys	Function
Ⓔ + ⬅ (at least for 3 sec)	Enter/quit Full Parameter Programming mode. Entering programming mode parameter modified last time is blinking.

During programming „PROG“ is lit while the screen is as below:

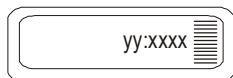

yy      Parameter address (P01, P02 ... P99)  
 xxxx    Parameter value (dcba)  
 Bargraph

Measuring is going on during programming in accordance with the old parameter set. New parameter set will be valid after returning to the Measurement Mode.

### Steps and indications of the Full Parameter Access programming mode

Pressing Keys	While Parameter address is blinking	While Parameter value is blinking
Ⓔ	Selecting parameter address and step to the parameter value	Modification of the parameter values will be saved. Return to the parameter address.
⬅ + ⬆	Cancel all modifications of the actual programming phase. Pressing for 3 sec is required while CANCEL will be displayed for warning	Modification of the parameter value will be neglected. Return to the parameter address without saving the modifications.
⬅ + ⬇	Device will be returned to Factory Default. Since all parameters will be overwritten "LOAD" will appear on the display first: – to confirm, press Ⓔ – to escape, press any other key	Default parameter will be loaded (and saved by pressing ENTER Ⓔ).
⬅	Move blinking (changeability) of the digit to the left	
⬆ / ⬇	Modify the blinking digit (increase, decrease) or scroll up/down	

## 6. PARAMETERS – DEFINITIONS AND PROGRAMMING

### 6.1. MEASUREMENT CONFIGURATION

P00: - c b a Engineering Unit System

Factory default will be reloaded in the corresponding engineering units by programming this parameter. Therefore all parameters have to be set again.

a	Operating mode
0	Always 0

b	Engineering units (according to „c“)	
	Metric	US
0	m	ft
1	cm	Inch

c	Calculation system
0	metric
1	US

DEFAULT: 000

**Attention: mind the sequence!**  
**When programming this parameter the right side value “a” will be blinking first.**



**P01: --- a Measurement mode**

Parameter value „a” will determine the basic measurement value that will be displayed and proportional with the current output. Depending on the value of “a” process values as listed in the 3<sup>rd</sup> column can also be displayed by pressing NEXT (→). For return to the display of the basic value the ENTER (↵) key should be pressed.

a	Measurement mode Transmitted value	Display symbol	Displayed values
0	Capacitance %	%	Percentage
1	Level	LEV	Level
2	Level percentage	LEV%	Level percentage, Level
3	Volume	VOL	Volume, Level
4	Volume percentage	VOL%	Volume percentage, Volume, Level

**Attention: mind the sequence!**  
**When programming this parameter the right value “a” will be blinking first.**

Note:

*If the change of the level is proportional with the change of the capacitance there will be no difference between relative % (a = 0) and level % (a = 2).*

DEFAULT: 0

**P02: -- b a Engineering units**

a	
0	Always 0

**Attention: mind the sequence!**  
**When programming this parameter the right value “a” will be blinking first.**

This table is to be understood according to P00(c) and P01(a) and irrelevant with measuring percentage ( P01(a)= 2 or 4 )

b	Volume		Weight (See also P32)	
	Metric	US	Metric	US
0	m <sup>3</sup>	ft <sup>3</sup>	tonne	lb (pound)
1	litre	gallon	tonne	tonne

DEFAULT: 00

### P03: - - - a Displayed values – Rounding

#### Volume (VOL) display

Value displayed	Display arrangement
0,000 – 9,999	x,xxx
10,000 – 99,999	xx,xx
100,000 – 999,999	xxx,x
1000,000 – 9999,999	xxxx,x
10000,000 – 99999,999	xxxxx,x
100000,000 – 999999,999	xxxxxx,x
1 million – 9,99999*10 <sup>9</sup>	x,xxxx : e (exponential form)
over 1 x 10 <sup>10</sup>	(overflow) Err4

Decimal position will be shifted with increasing value displayed.  
(See table at the left).

Values over one million will be displayed in exponential format whereas the value (e) represents the exponent. Over the value of 1x10<sup>10</sup> Err4 (overflow) will be displayed.

#### Rounding

Parameter value “a”	Steps in the displayed values
0	1 (no rounding)
1	2
2	5
3	10
4	20
5	50

A couple of millimetres of fluctuation of the basic DIST value (e.g. due to waves) will be enlarged by the mathematical operations. This enlarged fluctuation in displaying VOL or FLOW can (if disturbing) be avoided by rounding to be set in **P03**. Rounding value 2, 5, 10 etc represents the steps by which the calculated value will be changed in its (one or two) last digit(s).

Examples:

**P03** = 1 steps by 2: 1,000; 1,002; 1,004

**P03** = 5 steps by 50: 1.000; 1.050; 1,100 or 10.00; 10.05(0); 10.10(0); 10,15(0) (the 0 from the steps 50, 100, 150 etc will not be displayed)

DEFAULT: 0

### P05: Lower (learning) level of the operating range

Programming this parameter 0% of level will be assigned to the capacitance measured in the actual application i.e. the unit will “learn” conditions of the application

Programming can be started by double key pressing of  $\uparrow$  +  $\downarrow$ . While learning „Store” will be displayed.

### P06: Upper (learning) level of the operating range

Programming this parameter 100% of level will be assigned to the capacitance measured in the actual application i.e. the unit will “learn” conditions of the application

Programming can be started by double key pressing of  $\uparrow$  +  $\downarrow$ . While learning „Store” will be displayed.

*If level, level percentage, volume or volume percentage should be measured (a ≠ 0 in P01) as well as level and volume should be read with relevant engineering units, then first data pair (e.g. 0% and corresponding minimum level in [m]) and last two data pair (e.g. 100% and corresponding maximum level in [m]) of the linearisation table should be entered. Obviously linearisation must be switched ON. (See P47 and P48 on page 29 and 30)*

## Programming of partially filled tank

Not only the minimum (0%) and maximum (100%) level of the actual application can be assigned (directly) to the 4 and 20 mA output.

If for some reasons of the technology the tank can not be filled to the maximum or emptied to the minimum level the 4 and the 20 mA can (indirectly) also be assigned to the minimum (0 %) and maximum (100 %) with the help of two intermediate levels (say to 15% and to 80%).

Obviously - for the sake of accuracy – it is advised to fill/empty the tank to the maximum/minimum level and perform “direct” assignment as soon as possible. The unit can also be programmed for inverse operation (4 mA = full and 20 mA = empty).

## 6.2. CURRENT OUTPUT

If in **P01 a=0**, this programming step is irrelevant.

If level, level percentage, volume or volume percentage should be measured (a ≠ 0 in **P01**) as well as first and last data pair of the linearisation table have been entered then in the procedure of the data handling the minimum and maximum values (level or volume) are in engineering units available.

Since current outputs should be assigned to these values in parameters **P10** and **P11** are the level and volume values entered.

**P10:** **Assignment of 4 mA to the minimum level, level percentage, volume or volume percentage.**

**P11:** **Assignment of 20 mA to the maximum level, level percentage, volume or volume percentage.**

DEFAULT:

**P10:** 0

**P11:** 9999

**P12: - - - a** **“Error” indication by the current output**

“Error” condition will be indicated by the current output. This indication below is on as long as the error lasts.

a	“Error” indication
1	3.8 mA
2	22 mA

DEFAULT: 2

### 6.3. MEASUREMENT OPTIMALISATION

#### P20: - - - a Damping

This parameter can be used to reduce unwanted fluctuation of the display and output.

a	Damping (sec)	Remark
0	No damping	
1	3	Applicable
2	6	Recommended
3	10	Recommended
4	30	Recommended
5	60	Recommended
6	100	Applicable
7	300	Applicable

DEFAULT: 10 sec

#### P32: Density of the medium (kg/dm<sup>3</sup> or lb/ft<sup>3</sup> in accordance with setting of (c) in P00)

If entering value other than 0 weight will be displayed (in kg/dm<sup>3</sup> or lb/ft<sup>3</sup> in accordance with setting of (c) in **P00** and (b) in **P02**) instead of volume

DEFAULT: 0

### 6.4. VOLUME MEASUREMENT

#### P40: - - ba Tank shape

ba	Tank shape	Parameters programmed
b0	Standing cylindrical tank domed shape bottom (value of "b" as below)	P40(b), P41
01	Standing cylindrical tank with conical bottom	P41, P43, P44
02	Standing rectangular tank (with chute)	P41, P42, P43, P44, P45
b3	Lying cylindrical tank shape (value of "b" as below)	P40(b), P41, P42
04	Spherical tank	P41

DEFAULT: 0

**Attention!**  
The value „a” determining the shape of the tank should be set first.

## P41-45: Tank dimensions

Standing cylindrical tank  
domed shape bottom  
 $a = 0$

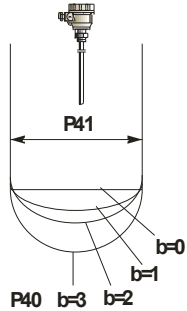

Standing cylindrical  
tank with conical  
bottom  
 $a = 1, b = 0$

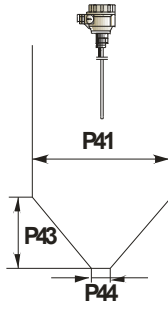

Standing rectangular  
tank  
 $a = 2, b = 1$

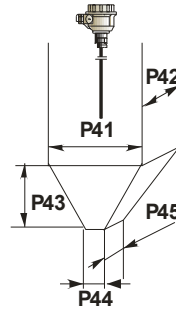

Lying cylindrical tank shape  
 $a = 3$

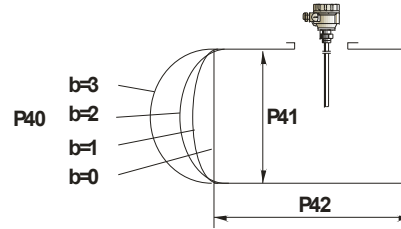

Spherical tank  
 $a = 4, b = 0$

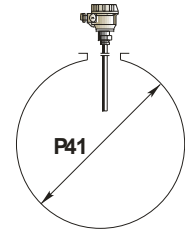

Flat  
bottom  
P43, P44  
and  
P45 = 0

For the programming procedure see: 5.2.1.

## 6.5. 32-POINT LINEARISATION

Programming 32 point linearisation % (0 ... 100%)-capacitance can be assigned to the values of level and volume by data pairs. Intermediate values will be calculated by interpolation. See the example for volume calculation:

- 1, Select engineering unit (P00).
- 2, Select operating mode (P01).
- 3, Programme required levels (P05, P06).
- 4, Activate linearisation (P47=1)
- 5, Assuming lower and upper level being 1 and 5 m respectively first data pair to enter in the table is: 0% - 1 m, and the last data pair 100% - 5 m.
- 6, Select your tank shape (P40), enter dimensions (P40-P45).
- 7, Perform programming of P10 and P11.

P47: - - - a Linearisation active/disabled

a	Linearisation
0	disabled
1	active

## P48: Linearisation table

Linearisation table is represented by 32 point data pairs containing capacitance in the left column (indicated by “L”-on the display) and LEVEL, VOLUME or WEIGHT in the right column (indicated by “r”-on the display).

Left column “L”	Right column “r”
Capacitance percentage	LEVEL, VOLUME or WEIGHT

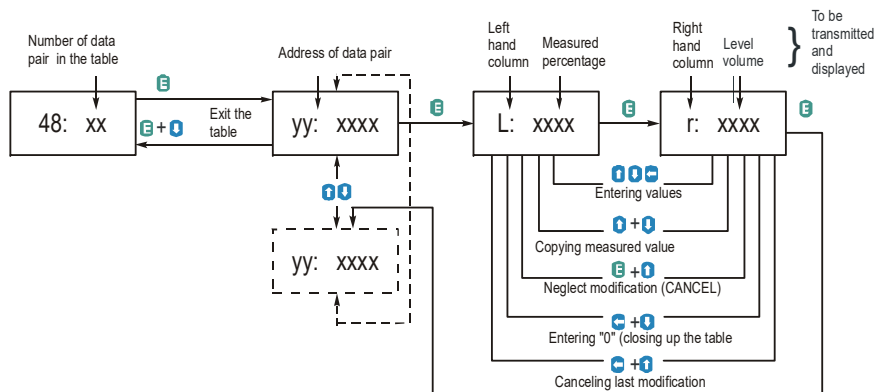

After entering data pairs the unit will arrange them into increasing sequence of order even if they have not been entered so. Should this arranging be unsuccessful failure will be indicated by the unit.

### Correct programming of the data pair

LEFT COLUMN „L”	RIGHT COLUMN „r”
L(1) = 0	r(1)
L(i)	r(i)
:	:
L(j)	r(j)

First data in the table should be: L(1) = 0%. Last data in the table should be j = 32 or L(j) = 0.

Table should always contain data L(i) = 100%

Should the linearisation table contain less than 32 data pairs (j < 32) so the left column of the table must be closed with 0: L(j < 32) = 0.

The NIVOCAP will ignore data after recognising level value “0” with the serial number other than “1”.

If the above conditions are not fulfilled error will be indicated (see Chapter Error Codes)

## 6.6. SERVICE PARAMETERS (READ ONLY)

### P60: Overall operating hours of the unit (h)

Display of the elapsed time

NUMBER OF OPERATING HOURS	INDICATION FORM
0 to 999,9 h	xxx,x
1000 to 9999 h	xxxx
Over 9999 h	x,xx:e represents $x,xx \cdot 10^e$

### P61: Time elapsed after last switch-on (h)

Indication form as under P60

## 6.7. TEST PARAMETERS

### P80: Current (generator) output test (mA)

Going to this parameter, the actual current output (corresponding to the measured process value) will be displayed. By pressing ENTER  $\text{Ⓔ}$  the (now blinking) current value can be set for any value between 3,9 and 20.5 mA. The current output has to show the same value which can be checked by an ampere meter, according to the description under 4.4. Press ENTER  $\text{Ⓔ}$  to quit test mode and return the parameter address

### P96: b:a.aa Software code

**a.aa:** Number of the software version

**b:** Code of the special version

## 6.8. SIMULATION

This function enables the user to test the settings of the outputs. The NIVOCAP can simulate the static or continuous change of level according to the simulation cycle time, high level and low level set in **P85**, **P86** and **P87**. (The simulation levels must be within the programmed measuring range set in **P04** and **P05**.)

After selecting simulation type in **P84** and setting simulation values Measurement Mode has to be re-entered. While the NIVOCAP is in simulation mode the DIST, LEV or VOL symbol will be blinking. To quit Simulation Mode **P84=0** should be set.

### P84: ---x Selection of simulation

X	SIMULATION TYPE
0	No simulation
1	Level change between <b>P86</b> and <b>P87</b> by cycle time <b>P85</b>
2	Simulation of continuous level according to <b>P86</b>

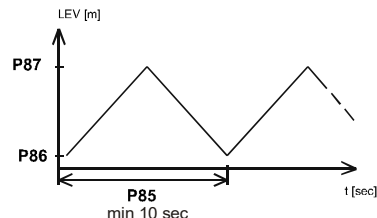

**P85:** Cycle time of simulation (sec)

**P86:** Simulated low level (m)

**P87:** Simulated high level (m)

## 6.9. ACCESS LOCK

### P99: dcba Lock of programming by access lock

The purpose of this feature is to provide protection against accidental (or intentional) re-programming of parameters.

The Secret Code can be any value other than **0000**. Setting a Secret Code will automatically be activated when the NIVOCAP is returned to the Measurement Mode. If the Secret Code is activated, the parameters can only be viewed, this is indicated by the a flashing colon ":" between the parameter address and the parameter value.

In order to program the device locked by a secret code, first enter the Secret Code in **P99**. The Secret Code is re-activated each time the NIVOCAP is returned to Measurement Mode.

To delete the Secret Code, enter the Secret Code in **P99**. After confirming it with **[E]** re-enter the parameter **P99** and enter **0000**.

**[dcba (Secret Code)] → [E] → [E] → [0000] → [E] ⇒ Secret Code deleted**



## 7. ERROR CODES

ERROR CODE	ERROR DESCRIPTION	WHAT TO DO	OVERWRITING INDICATION	LED-BLINKING	CURRENT OUTPUT
1	Memory failure	Contact service	Yes	Continuous	22 mA
2	Capacitance to be measured is too high or damaged probe insulation (Level over the upper limit)	Check adjustment and installation conditions. Check the probe. Repeat programming (teaching)!	Yes	2	Programmed
3	Hardware failure (EEPROM communication failure)	Contact service	Yes	Continuous	22 mA
4	Display overflow	Check adjustment	Yes	-	No influence
5	Capacitance to be measured is too small or no signal from the probe (short-circuit).	Check installation conditions		2	Programmed
6	Measuring at the limit of reliability. No legible signal (Noise, Electromagnetic disturbance)	Eliminate source of disturbance Change the position of the probe or relocate it.	Yes	2	Programmed
12	Linearisation failure: L(1) and L(2) zero (no valid data pair)	See „Linearisation“	Yes	3	22 mA
13	Linearisation table failure: two L(i) in the table	See „v Linearisation“	Yes	3	22 mA
14	Linearisation table failure: r(i) values are not increasing continuously.	See „Linearisation“	Yes	3	22 mA
15	Linearisation table failure: no value assigned to the measured one	See „Linearisation“	Yes	3	22 mA
16	Incorrect checksum	Check programming. Change any parameter and recheck the checksum. Should the same error come out contact service!	Yes	3	22 mA

ERROR CODE	ERROR DESCRIPTION	WHAT TO DO	OVERWRITING INDICATION	LED-BLINKING	CURRENT OUTPUT
18	Hardware failure (Analogue card failure)	Contact service	Yes	Continuous	22 mA
19	Range adjustment failure ( <i>Capacitance to be measured is outside of the range available.</i> )	Check adjustment and installation conditions. Repeat programming (teaching)! Level changes during teaching may also cause this error	Yes	3	22 mA
unCAL	Incorrect programming (or teaching) of the max and min levels	Check adjustment and installation conditions. Repeat programming (teaching)!	Yes	Continuous, but blinking alternatively	Programmed
Sub 0	Level a 0% below (LEV-VOL mode)	Check adjustment if necessary	No	No	Saturated 3.9 mA
20	Level a 100% over (LEV-VOL mode)	Check adjustment if necessary	No	No	Saturated 20.5 mA

#### Failure indication on the LED:

- Continuous blinking of the LED-s with the same pulse represents hardware failure. The unit can not be programmed.
- Continuous alternative blinking of the LED-s represents incorrect adjustment (not calibrated for measurement) Correction: reprogramming of the upper and lower level.
- Blinking of the LED-s with the same pulse represents: two blinking measurement, three blinking adjustment failure.

## 8. SUMMARY OF THE PARAMETERS

Pr.	Page	Titel	Value			
			d	c	b	a
P00	24	Engineering unit system				
P01	25	Measurement mode				
P02	25	Engineering units				
P03	26	Rounding				
P04	–					
P05	26	Lower (learning) level				
P06	26	Higher (learning) level				
P07	–					
P08	–					
P09	–					
P10	27	Assignment of values to 4 mA current output				
P11	27	Assignment of values to 20 mA current output				
P12	27	„Error“ indication by the current output				
P13	–					
P14	–					
P15	–					
P16	–					
P17	–					
P18	–					
P19	–					
P20	28	Damping				
P21	–					
P22	–					
P23	–					
P24	–					
P25	–					
P26	–					
P27	–					

Pr.	Page	Titel	Value			
			d	c	b	a
P28	–					
P29	–					
P30	–					
P31	–					
P32	28	Density of the medium				
P33	–					
P34	–					
P35	–					
P36	–					
P37	–					
P38	–					
P39	–					
P40	28	Dimensions for volume measurement				
P41	29	Dimensions for volume measurement				
P42	29	Dimensions for volume measurement				
P43	29	Dimensions for volume measurement				
P44	29	Dimensions for volume measurement				
P45	29	Dimensions for volume measurement				
P46	–					
P47	29	Linearisation				
P48	30	Linearisation table				
P49	–					
P50	–					
P51	–					
P52	–					
P53	–					
P54	–					
P55	–					

Pr.	Page	Titel	Value			
			d	c	b	a
P56		–				
P57		–				
P58		–				
P59		–				
P60	31	Overall operating hours				
P61	31	Time elapsed after last switch- on				
P62		–				
P63		–				
P64		–				
P65		–				
P66		–				
P67		–				
P68		–				
P69		–				
P70		–				
P71		–				
P72		–				
P73		–				
P74		–				
P75		–				
P76		–				
P77		–				

Pr.	Page	Titel	Value			
			d	c	b	a
P78		–				
P79		–				
P80	31	Current (generator) output test				
P81		–				
P82		–				
P83		–				
P84	32	Simulation mode				
P85	32	Simulation cycle time				
P86	32	Simulation low level				
P87	32	Simulation high level				
P88		–				
P89		–				
P90		–				
P91		–				
P92		–				
P93		–				
P94		–				
P95		–				
P96	31	Software code				
P97		–				
P98		–				
P99	32	Access lock				

cbr2052a0600p\_05  
May, 2016

*NIVELCO reserves the right to change technical data without notice!*